

UNCSA

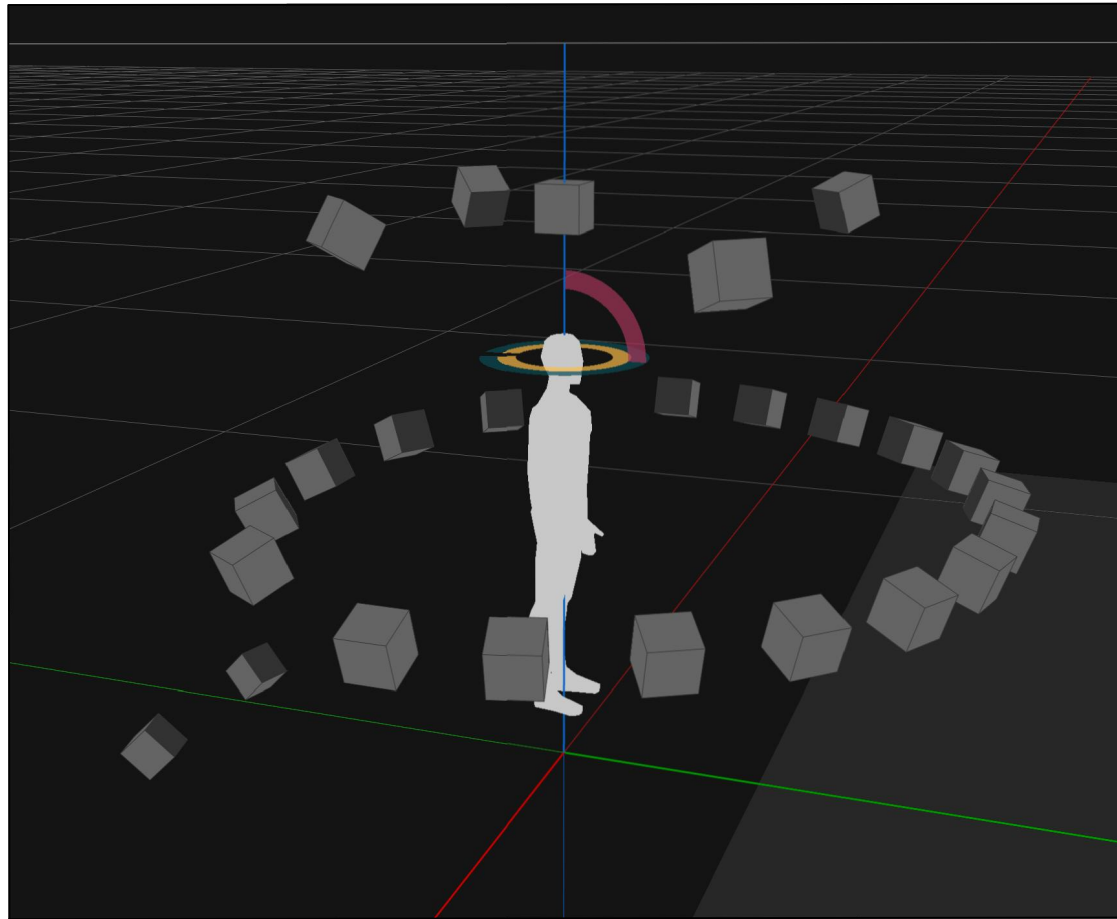

SOUNDSCAPE

SOUND DESIGNER  
NORA CUTHBERTSON

PRODUCTION SOUND ENGINEER  
MATTHEW KUPFERER

ASSISTANT SOUND DESIGNER  
ABI SENTHIL

# TABLE OF CONTENTS

1. TITLE PAGE
2. TABLE OF CONTENTS
3. SPEAKER PLOT – PLAN – OVERVIEW
4. SPEAKER PLOT – SECTION – OVERVIEW
5. SPEAKER PLOT – PLAN – GROUND – PLACEMENT
6. SPEAKER PLOT – PLAN – BOOM – PLACEMENT
7. SPEAKER PLOT – RIGGING DETAIL
8. BLOCK DIAGRAM
9. PATCH PLOT
10. POWER
11. FRONT COVERAGE
12. REAR COVERAGE
13. OH COVERAGE
14. NORA TIMESHEET
15. MATTHEW TIMESHEET
16. ABI TIMESHEET

LIBRARY CAFE

# PERFORMANCE PLACE

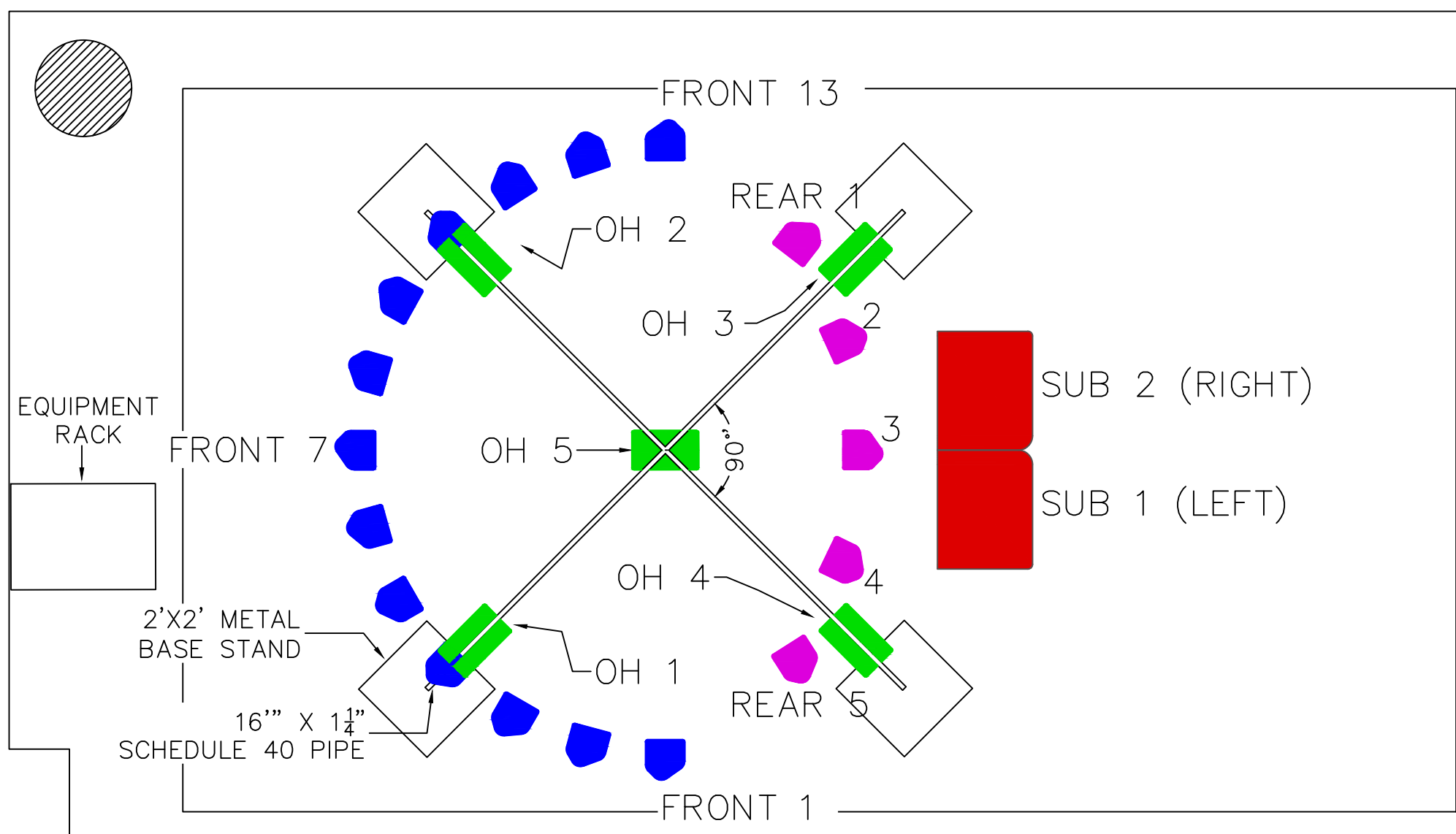

SHOW  
Soundscape 2.0

VENUE  
UNCSA Library

DESIGNER  
NORA CUTHBERTSON

DRAFTER  
MATTHEW KUPFERER

NOTES  
 - SUB 1&2 ARE L'ACOUSTICS KS21  
 - ALL OTHERS ARE L'ACOUSTICS X8

TITLE  
SPEAKER PLOT PLAN

PLATE  
3  
/22

DATE  
4-Apr-22

SCALE  
NO SCALE

FILENAME  
SOUNDSCAPE 3-25-AS.DWG

LIBRARY CAFE ↑

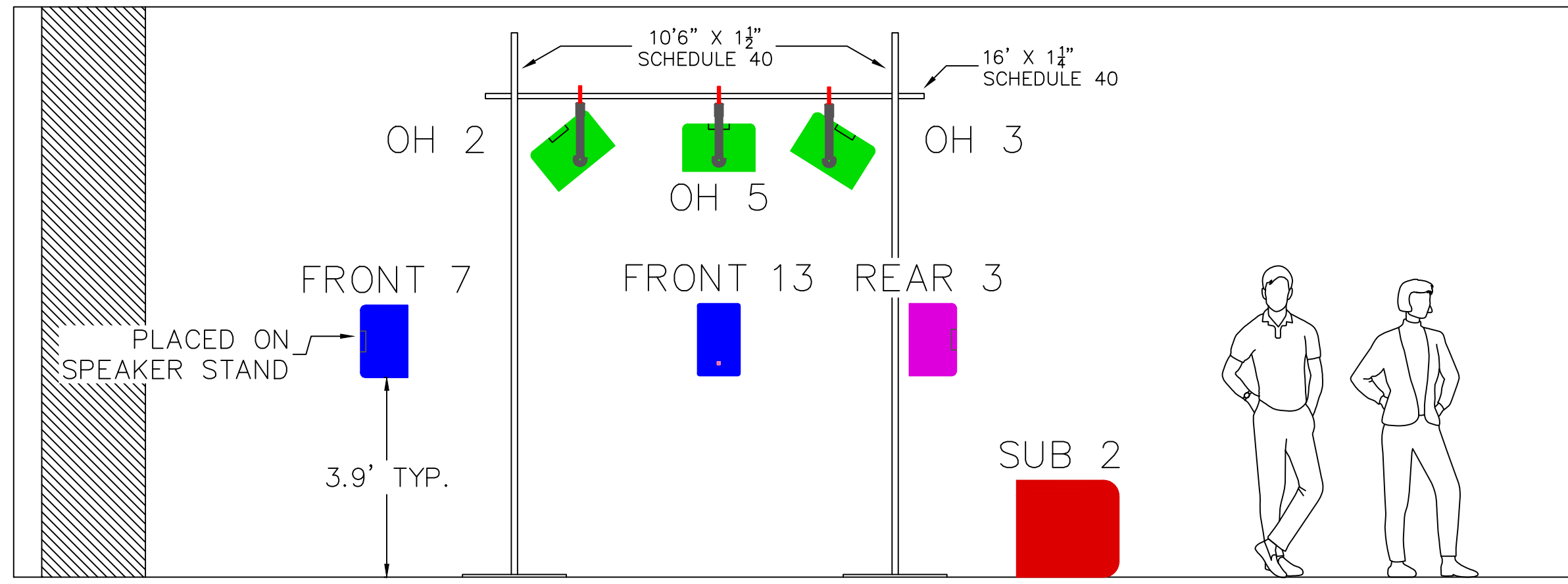

SHOW  
Soundscape 2.0

VENUE  
UNCSA Library

DESIGNER  
NORA CUTHBERTSON

DRAFTER  
MATTHEW KUPFERER

NOTES  
 - SUB 1&2 ARE L'ACOUSTICS KS21  
 - ALL OTHERS ARE L'ACOUSTICS X8  
 - SEE RIGGING DETAIL FOR OH YOKE/SPEAKER PLACEMENT

TITLE  
SPEAKER PLOT SECTION

PLATE  
4  
22

DATE  
4-Apr-22

SCALE  
NO SCALE

FILENAME  
SOUNDSCAPE 3-25-AS.DWG



LIBRARY CAFE

# PERFORMANCE PLACE

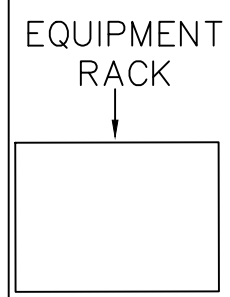
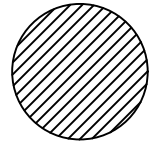
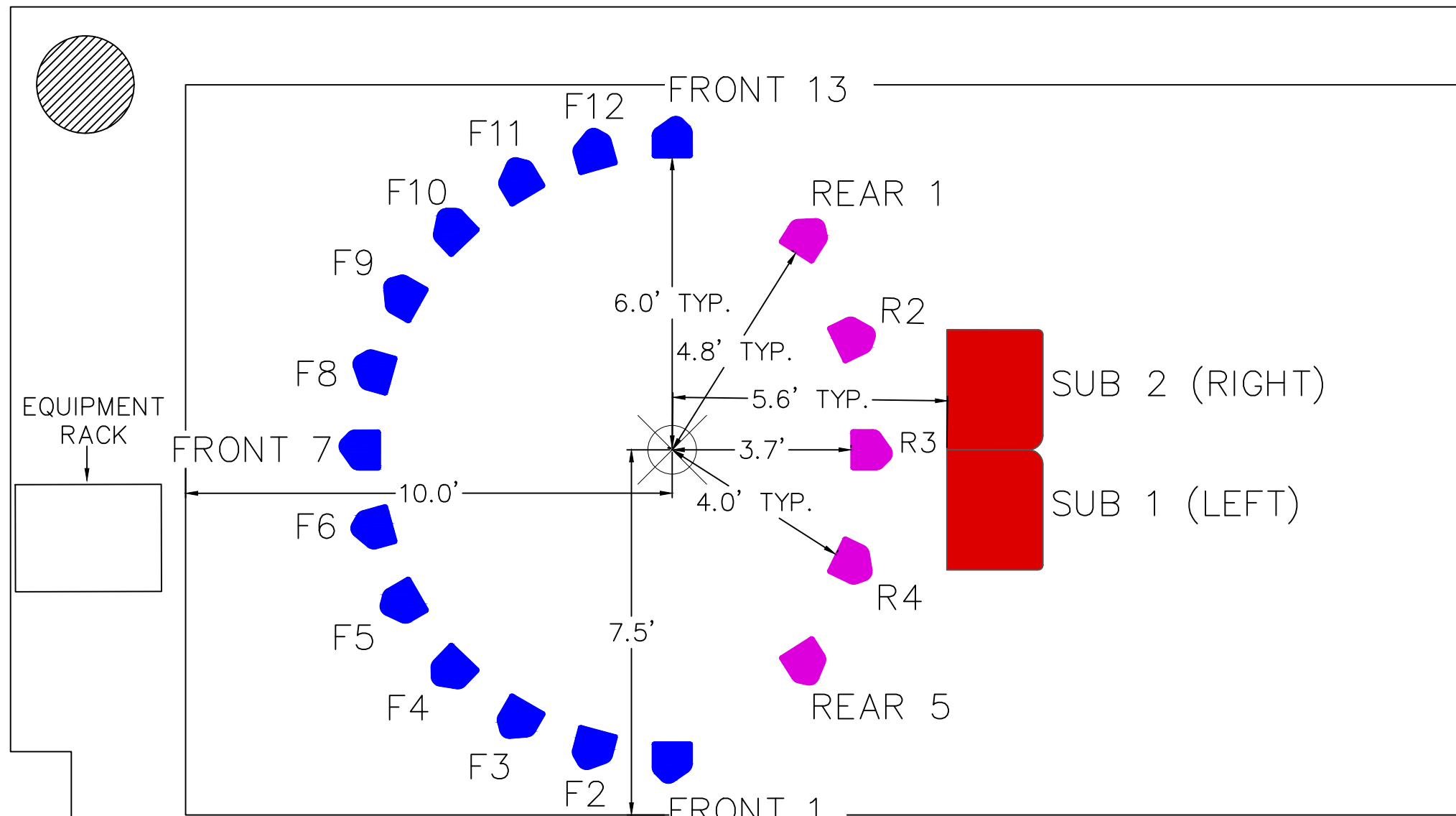

SHOW  
Soundscape 2.0

VENUE  
UNCSA Library

DESIGNER  
NORA CUTHBERTSON

DRAFTER  
MATTHEW KUPFERER

NOTES  
 - SUB 1&2 ARE L'ACOUSTICS KS21  
 - ALL OTHERS ARE L'ACOUSTICS X8

TITLE  
SPEAKER PLOT  
PLAN - GROUND  
PLACEMENT

PLATE  
5  
22

DATE  
4-Apr-22

SCALE  
NO SCALE

FILENAME  
SOUNDSCAPE 3-25-AS.DWG

# PERFORMANCE PLACE↑

LIBRARY CAFE↑

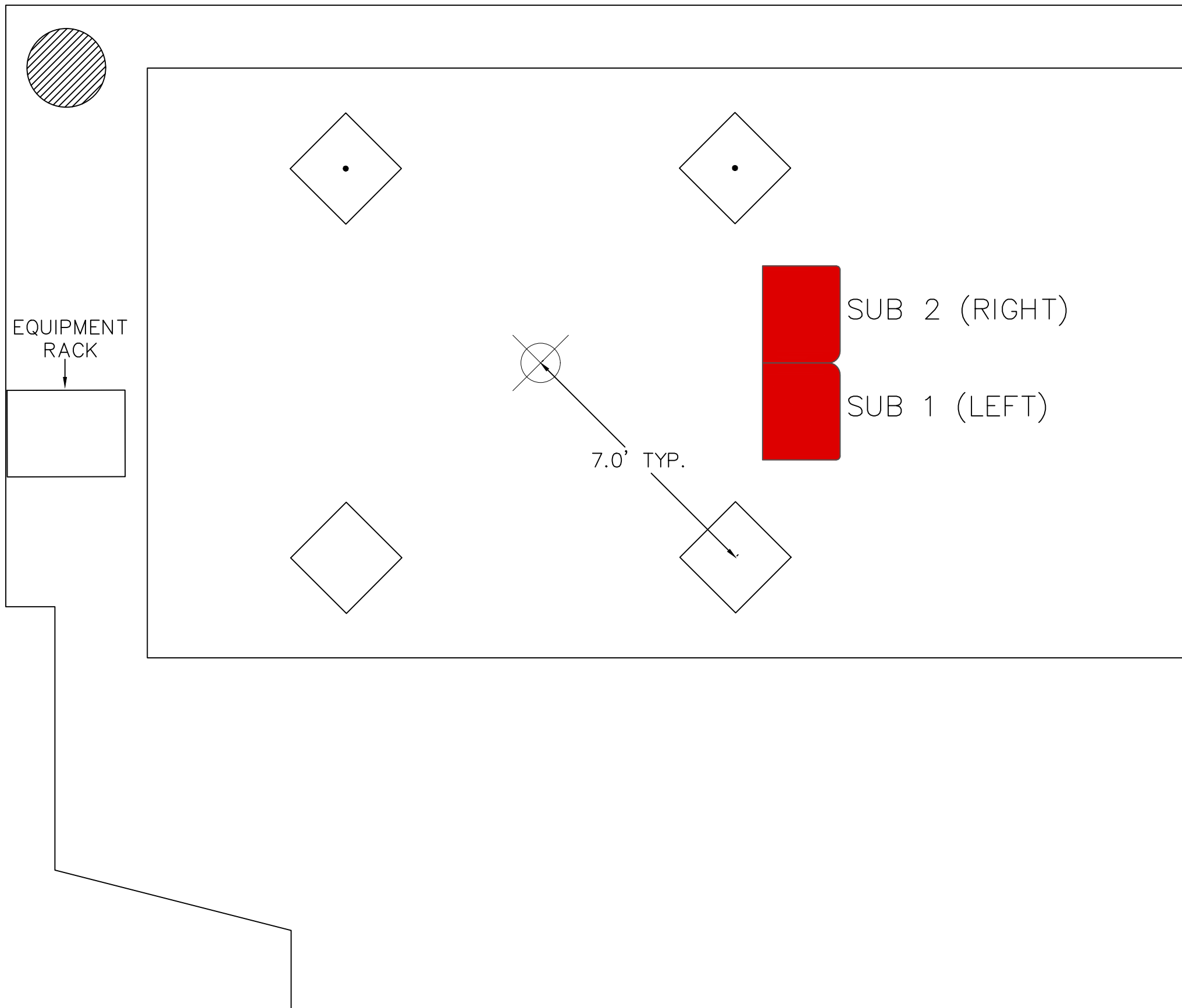

SHOW  
Soundscape 2.0

VENUE  
UNCSA Library

DESIGNER  
NORA CUTHBERTSON

DRAFTER  
MATTHEW KUPFERER

NOTES

TITLE  
SPEAKER PLOT  
PLAN – BOOM  
PLACEMENT

PLATE  
6  
/22

DATE  
4-Apr-22

SCALE  
NO SCALE

FILENAME  
SOUNDSCAPE 3-25-AS.DWG

SHOW  
Soundscape 2.0

VENUE  
UNCSA Library

DESIGNER  
NORA CUTHBERTSON

DRAFTER  
MATTHEW KUPFERER

NOTES

NOTE:

- ALL HORIZONTAL PIPES SECURED IN THIS FASHION
- THE PIPE SUPPORTING OH 2&4 WILL BE ATTACHED 1½" HIGHER (13" FROM TOP).
- OH 3 (CENTER) HUNG AS CLOSE AS POSSIBLE TO INTERSECTION
- SAFETY CABLE ON THE CENTER OH TIES AROUND THE PIPE UNTIL THE SPEAKER BECOMES PARALLEL TO THE GROUND.

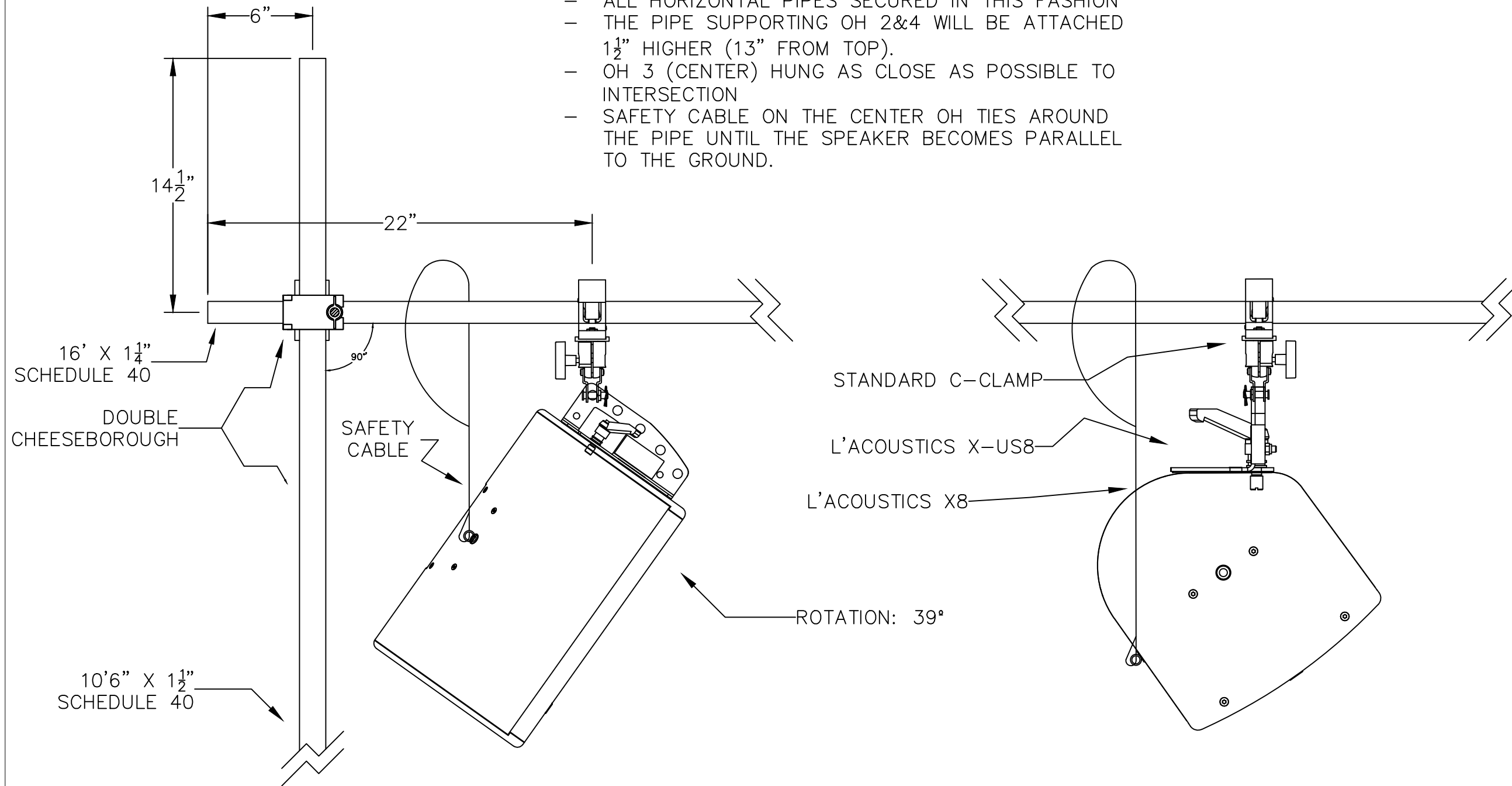

TITLE  
SPEAKER PLOT-  
RIGGING DETAIL

PLATE

7

22

DATE  
4-Apr-22

SCALE  
NO SCALE

FILENAME  
SOUNDSCAPE 3-25-AS.DWG

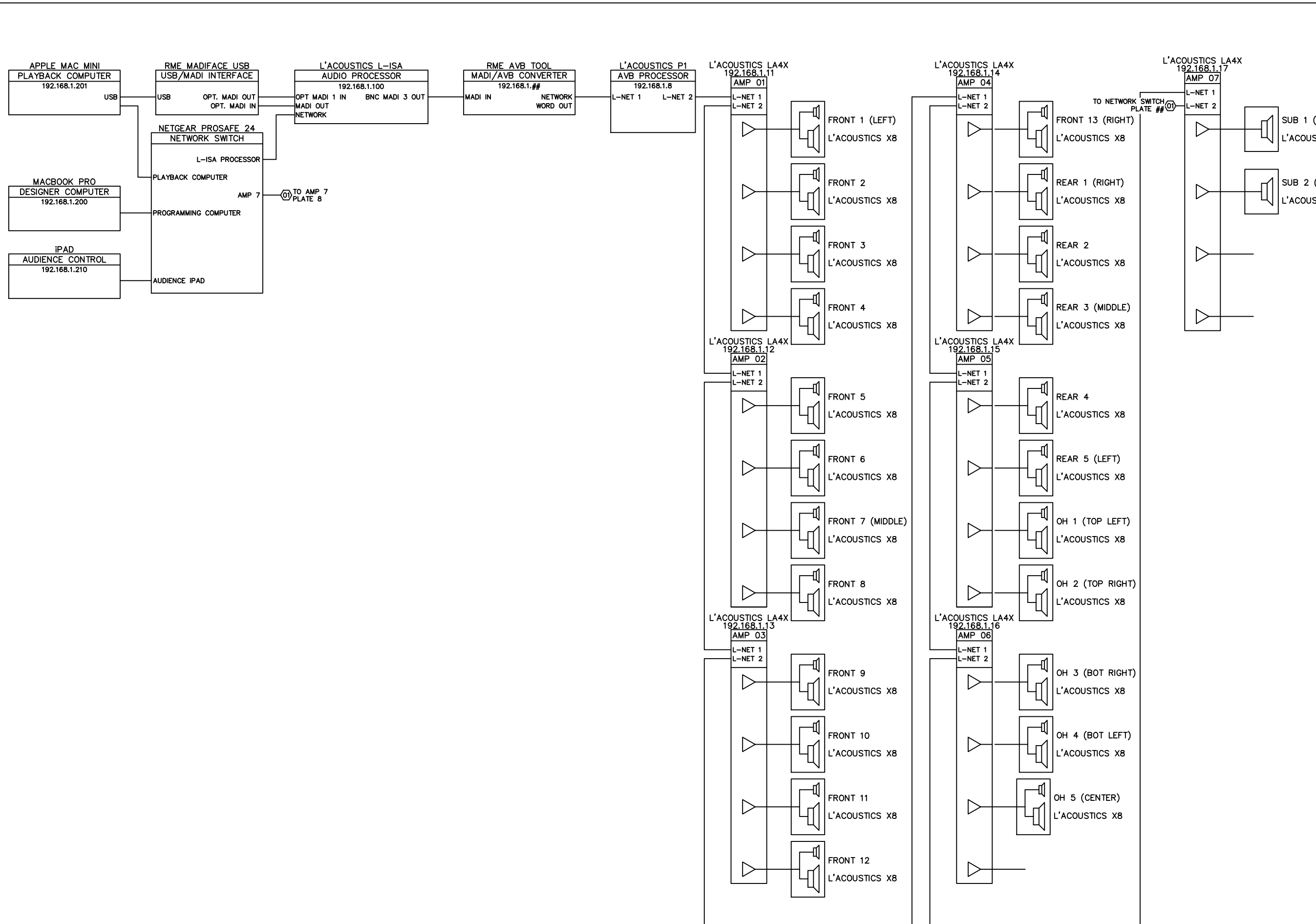

SHOW  
Soundscape 2.0

VENUE  
UNCSA Library

DESIGNER  
NORA CUTHBERTSON

DRAFTER  
MATTHEW KUPFERER

NOTES

TITLE  
SYSTEM  
DIAGRAM

PLATE  
8  
22

DATE  
4-Apr-22

SCALE  
NO SCALE

FILENAME  
SOUNDSCAPE 3-25-AS.DWG

Apple Mac Mini	USB-A S	USB-A P	Cable	USB-B P	USB-B S	USB2.0	RME MADiface USB	Opt. MADi Out	SC Fiber S	SC Fiber P	Cable	BNC P	SC Fiber S	IN	L-ISA Processor	3 OUT	BNC S	BNC P
----------------	---------	---------	-------	---------	---------	--------	------------------	---------------	------------	------------	-------	-------	------------	----	-----------------	-------	-------	-------

SHOW  
Soundscape 2.0

VENUE  
UNCSA Library

DESIGNER  
NORA CUTHBERTSON

DRAFTER  
MATTHEW KUPFERER

NOTES

Cable	BNC P	BNC S	MADI In	RME AVB Tool	Network	RJ45 S	RJ 45 P	Cable	RJ45 P	RJ45	L-NET 1	LA4X Amp 1	L-NET 2	RJ45 S	RJ45 P	Cable	RJ45 P	RJ45 S	L-NET 1	LA4X Amp 2
Out 1	NL4 S	NL2 P	Cable	NL2 P	NL4 S	L'Acoustics X8 Front 1 (Left)														
Out 2	NL4 S	NL2 P	Cable	NL2 P	NL4 S	L'Acoustics X8 Front 2														
Out 3	NL4 S	NL2 P	Cable	NL2 P	NL4 S	L'Acoustics X8 Front 3														
Out 4	NL4 S	NL2 P	Cable	NL2 P	NL4 S	L'Acoustics X8 Front 4														

L-NET 2	RJ45 S	RJ45 P	Cable	RJ45 P	RJ45 S	L-NET 1	LA4X Amp 3	L-NET 2	RJ45 S	RJ45 P	Cable	RJ45 P	RJ45 S	L-NET 1	LA4X Amp 4
Out 1	NL4 S	NL2 P	Cable	NL2 P	NL4 S	L'Acoustics X8 Front 5		Out 1	NL4 S	NL2 P	Cable	NL2 P	NL4 S	L'Acoustics X8 Front 9	
Out 2	NL4 S	NL2 P	Cable	NL2 P	NL4 S	L'Acoustics X8 Front 6		Out 2	NL4 S	NL2 P	Cable	NL2 P	NL4 S	L'Acoustics X8 Front 10	
Out 3	NL4 S	NL2 P	Cable	NL2 P	NL4 S	L'Acoustics X8 Front 7 (Middle)		Out 3	NL4 S	NL2 P	Cable	NL2 P	NL4 S	L'Acoustics X8 Front 11	
Out 4	NL4 S	NL2 P	Cable	NL2 P	NL4 S	L'Acoustics X8 Front 8		Out 4	NL4 S	NL2 P	Cable	NL2 P	NL4 S	L'Acoustics X8 Front 12	

L-NET 2	RJ45 S	RJ45 P	Cable	RJ45 P	RJ45 S	L-NET 1	LA4X Amp 5	L-NET 2	RJ45 S	RJ45 P	Cable	RJ45 P	RJ45 S	L-NET 1	LA4X Amp 6
Out 1	NL4 S	NL2 P	Cable	NL2 P	NL4 S	L'Acoustics X8 Front 13 (Right)		Out 1	NL4 S	NL2 P	Cable	NL2 P	NL4 S	L'Acoustics X8 Rear 4	
Out 2	NL4 S	NL2 P	Cable	NL2 P	NL4 S	L'Acoustics X8 Rear 1 (Right)		Out 2	NL4 S	NL2 P	Cable	NL2 P	NL4 S	L'Acoustics X8 Rear 5 (Left)	
Out 3	NL4 S	NL2 P	Cable	NL2 P	NL4 S	L'Acoustics X8 Rear 2		Out 3	NL4 S	NL2 P	Cable	NL2 P	NL4 S	L'Acoustics X8 OH 1 (Top Left)	
Out 4	NL4 S	NL2 P	Cable	NL2 P	NL4 S	L'Acoustics X8 Rear 3 (Middle)		Out 4	NL4 S	NL2 P	Cable	NL2 P	NL4 S	L'Acoustics X8 OH 2 (Top Right)	

L-NET 2	RJ45 S	RJ45 P	Cable	RJ45 P	RJ45 S	L-NET 1	LA4X Amp 7	Out 1	NL4 S	NL2 P	Cable	NL2 P	NL4 S	L'Acoustics KS 21 Sub 1 (Left)
Out 1	NL4 S	NL2 P	Cable	NL2 P	NL4 S	L'Acoustics X8 OH 3 (Bot Right)		Out 2	NL4 S	NL2 P	Cable	NL2 P	NL4 S	L'Acoustics KS 21 Sub 2 (Right)
Out 2	NL4 S	NL2 P	Cable	NL2 P	NL4 S	L'Acoustics X8 OH 4 (Bot Left)								
Out 3	NL4 S	NL2 P	Cable	NL2 P	NL4 S	L'Acoustics X8 OH 5 (Center)								

TITLE  
PATCH PLOT

PLATE  
9  
22

DATE  
4-Apr-22

SCALE  
NO SCALE

FILENAME  
SOUNDSCAPE 3-25-AS.DWG

UNAVAILABLE

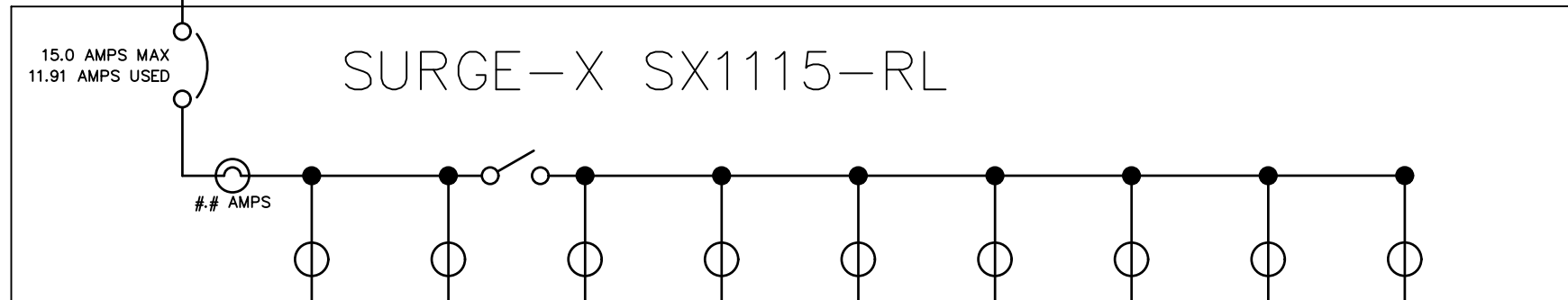

AUDIO PROCESSOR	MADI/AVB CONVERTER	AVB PROCESSOR	NETWORK SWITCH	PLAYBACK COMPUTER	AUDIENCE CONTROL	HARD DRIVE
L'ACOUSTICS L-ISA 0.5 AMPS	AVB TOOL RME 0.58 AMPS	L'ACOUSTICS P1 .03 AMPS	NETGEAR PROSAFE 24 1 AMP	APPLE MAC MINI 0.33 AMPS	APPLE IPAD 1 AMP	OWC THUNDERBLADE 2.0

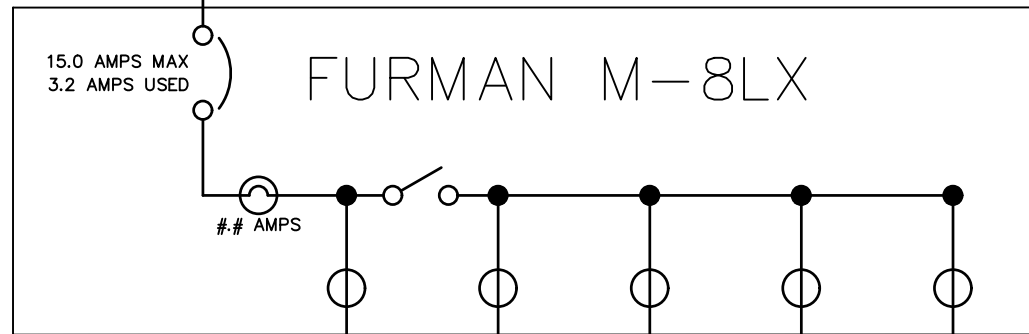

AMPLIFIER 1	AMPLIFIER 2	AMPLIFIER 3	SHOW CONTROL
L'ACOUSTICS LA4X 0.9 AMPS	L'ACOUSTICS LA4X 0.9 AMPS	L'ACOUSTICS LA4X 0.9 AMPS	APPLE IPAD 0.5 AMPS

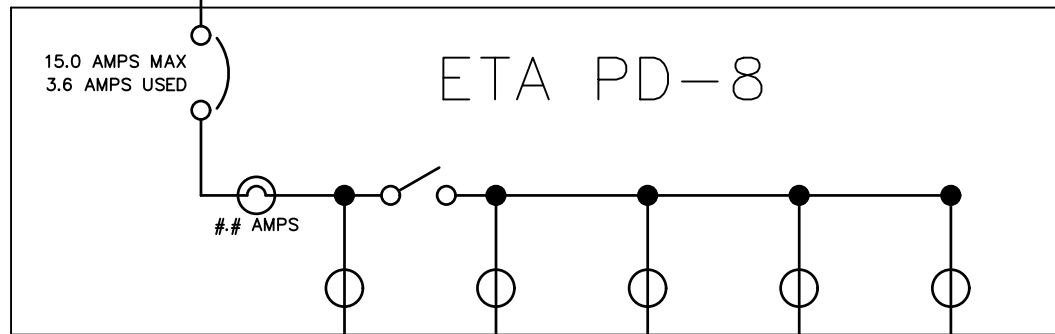

AMPLIFIER 4	AMPLIFIER 5	AMPLIFIER 6	AMPLIFIER 7
L'ACOUSTICS LA4X 0.9 AMPS	L'ACOUSTICS LA4X 0.9 AMPS	L'ACOUSTICS LA4X 0.9 AMPS	L'ACOUSTICS LA4X 0.9 AMPS

SHOW  
Soundscape 2.0

VENUE  
UNCSA Library

DESIGNER  
NORA CUTHBERTSON

DRAFTER  
MATTHEW KUPFERER

NOTES

- ROOM 1308 IS DOWN THE HALL, PAST THE BATHROOMS, TO THE RIGHT THROUGH 'STAFF ONLY' DOORS, ON THE LEFT SIDE
- FOR BREAKER RESET DURING HOURS, CALL CHRIS BOWMAN (336.345.9857)
- AFTER HOURS, CALL CAMPUS POLICE (336.770.3321)

TITLE  
POWER DIAGRAM

PLATE  
10  
22

DATE  
4-Apr-22

SCALE  
NO SCALE

FILENAME  
SOUNDSCAPE 3-25-AS.DWG

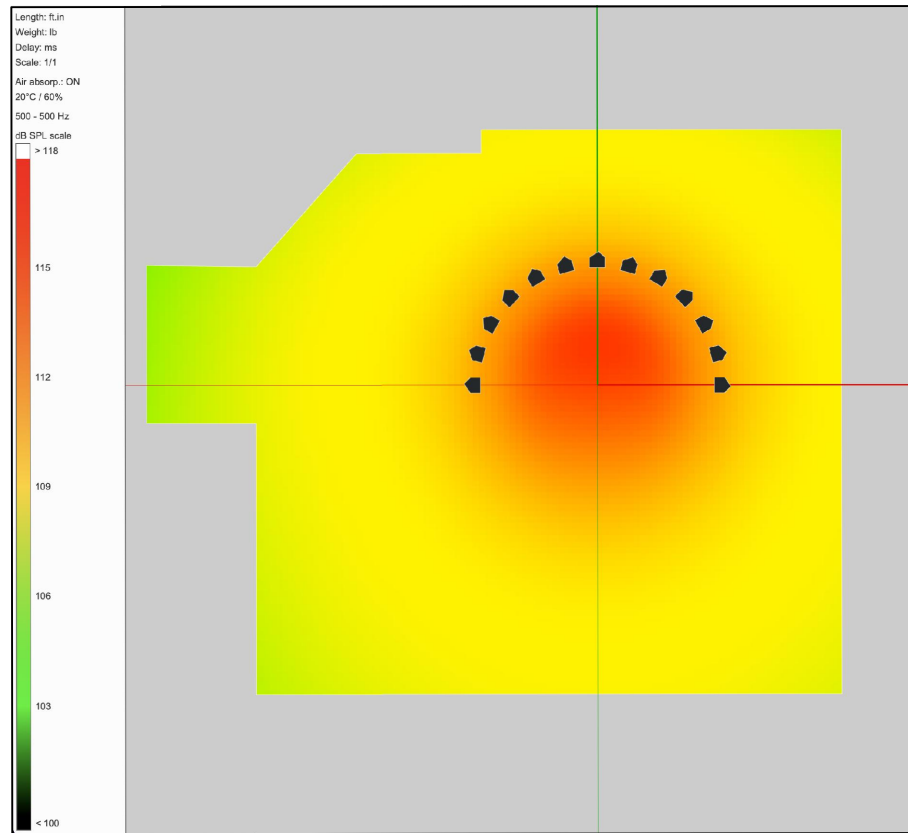

500Hz

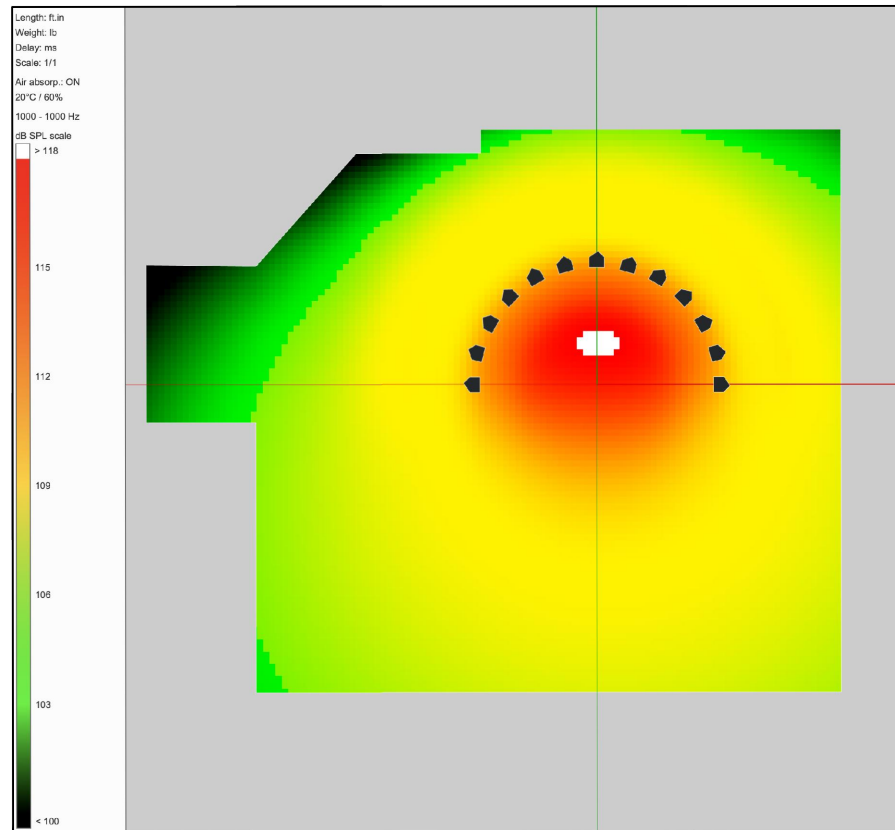

1KHz

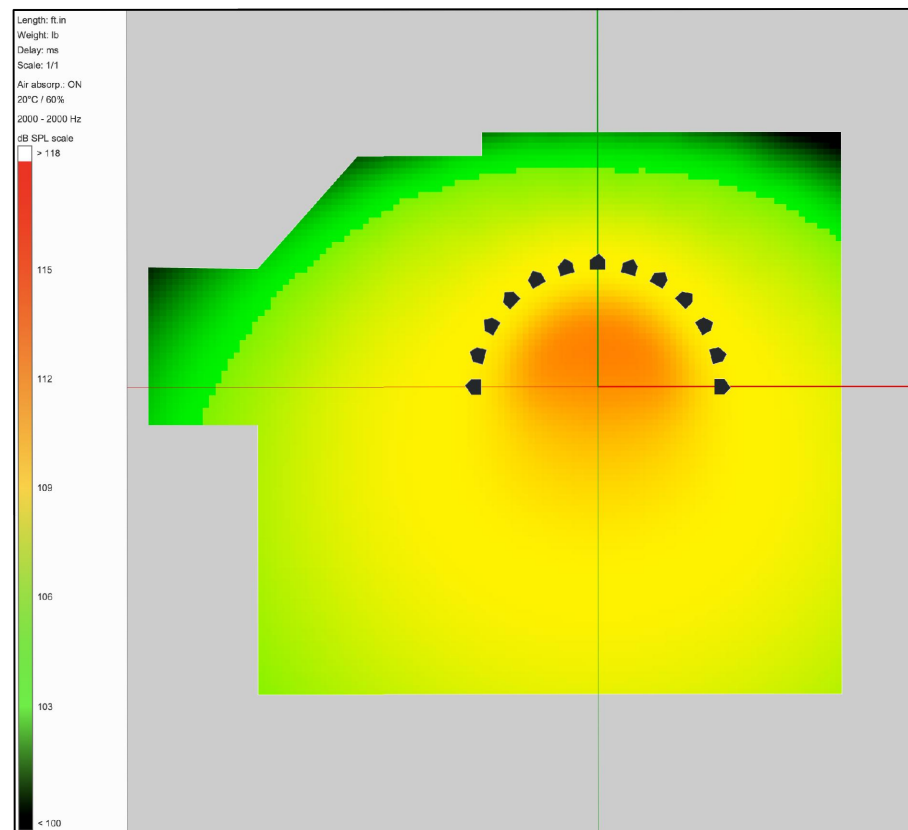

2KHz

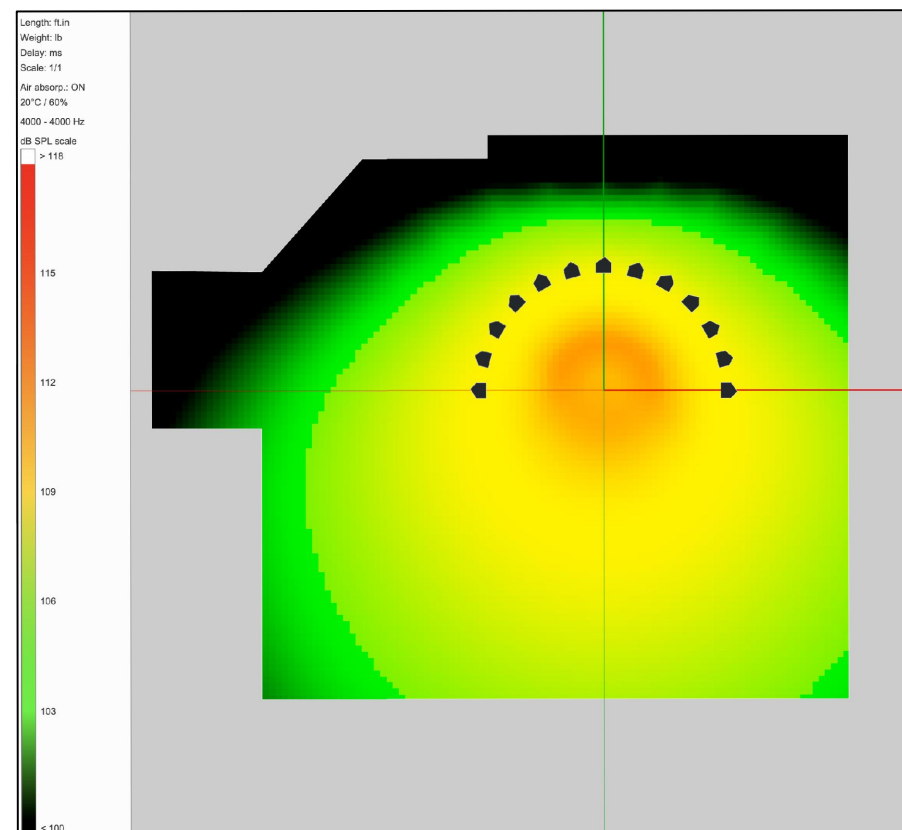

4KHz

SHOW  
Soundscape 2.0

VENUE  
UNCSA Library

DESIGNER  
NORA CUTHBERTSON

DRAFTER  
MATTHEW KUPFERER

NOTES

TITLE  
FRONT  
COVERAGE

PLATE  
11  
22

DATE  
4-Apr-22

SCALE  
NO SCALE

FILENAME  
SOUNDSCAPE 3-25-AS.DWG



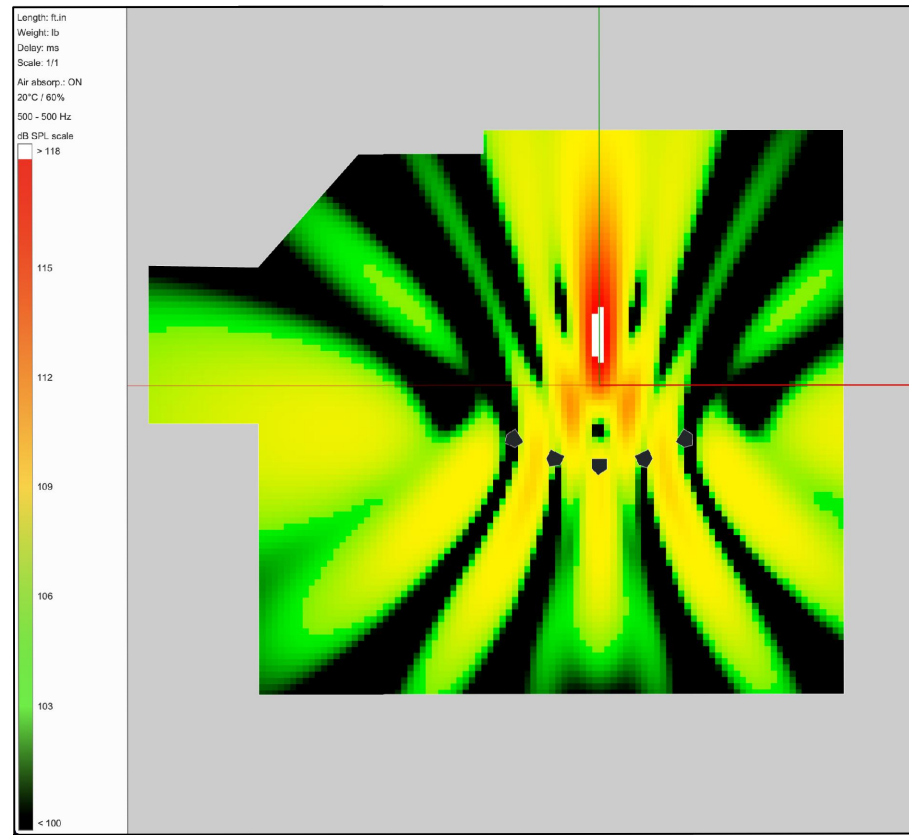

500Hz

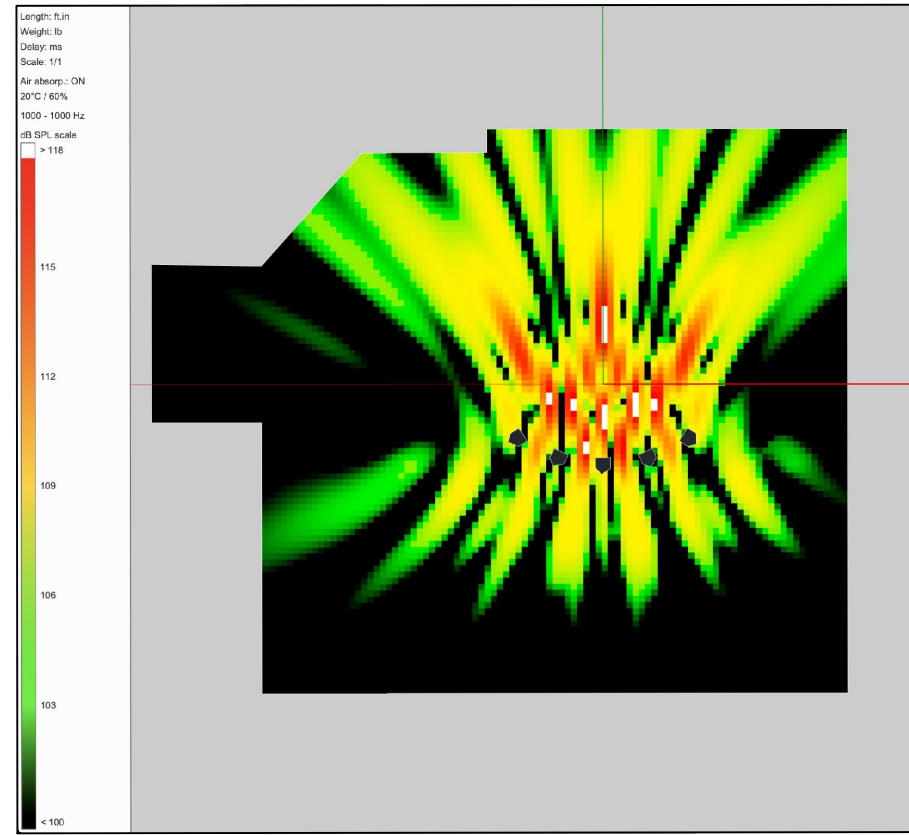

1KHz

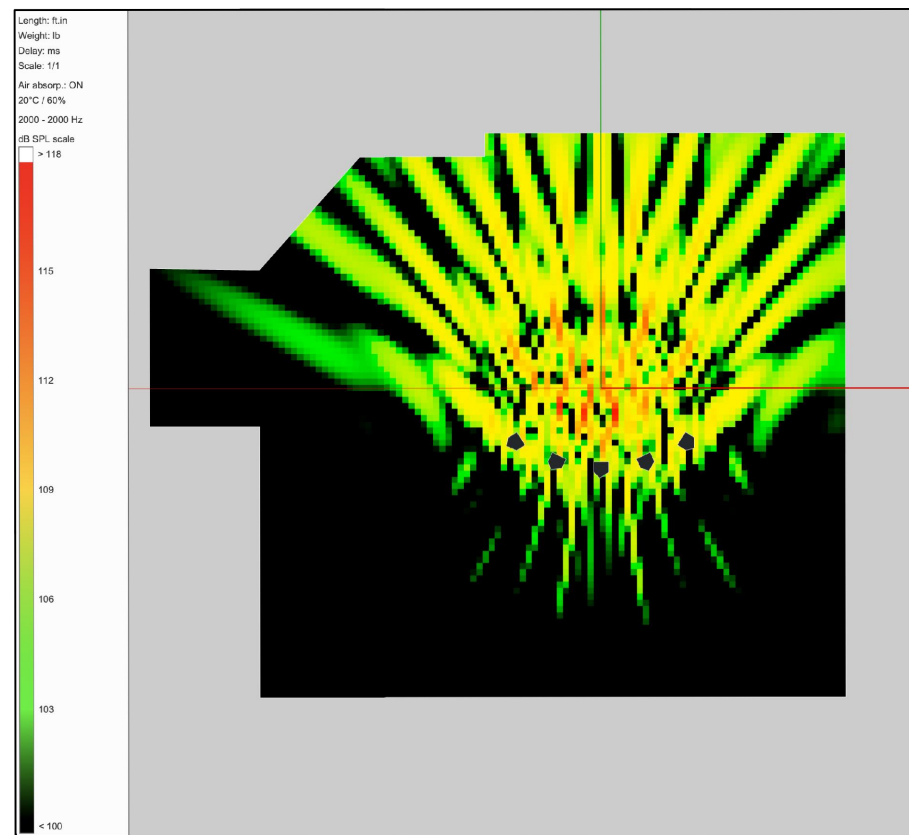

2KHz

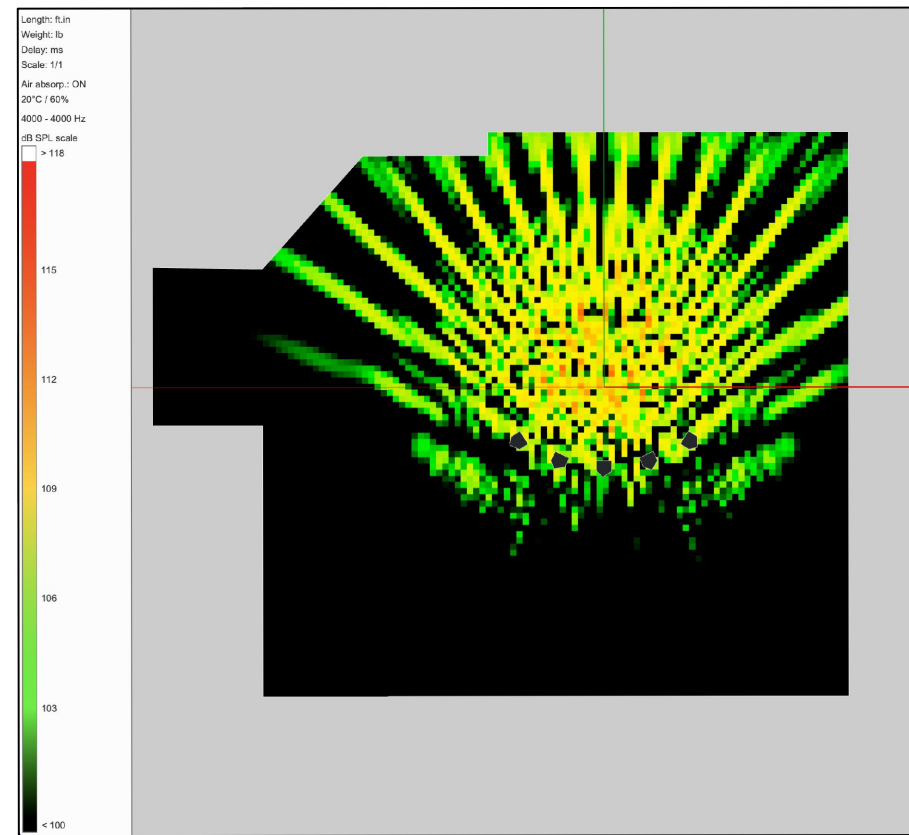

4KHz

SHOW  
Soundscape 2.0

VENUE  
UNCSA Library

DESIGNER  
NORA CUTHBERTSON

DRAFTER  
MATTHEW KUPFERER

NOTES

TITLE  
REAR  
COVERAGE

PLATE  
12  
/22

DATE  
4-Apr-22

SCALE  
NO SCALE

FILENAME  
SOUNDSCAPE 3-25-AS.DWG



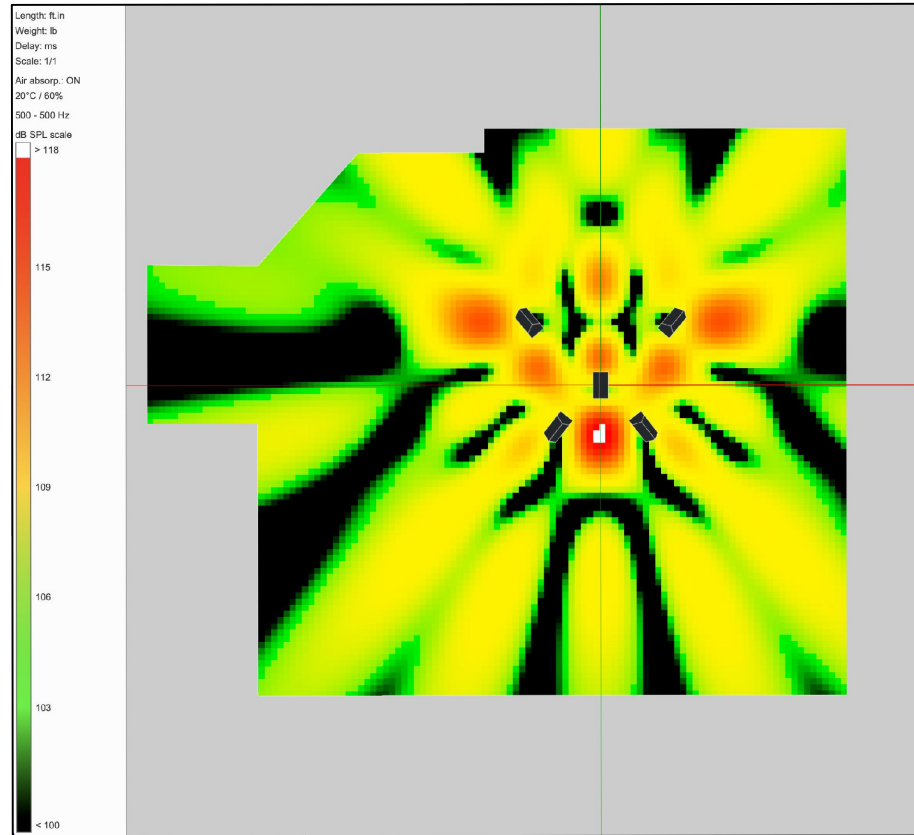

500Hz

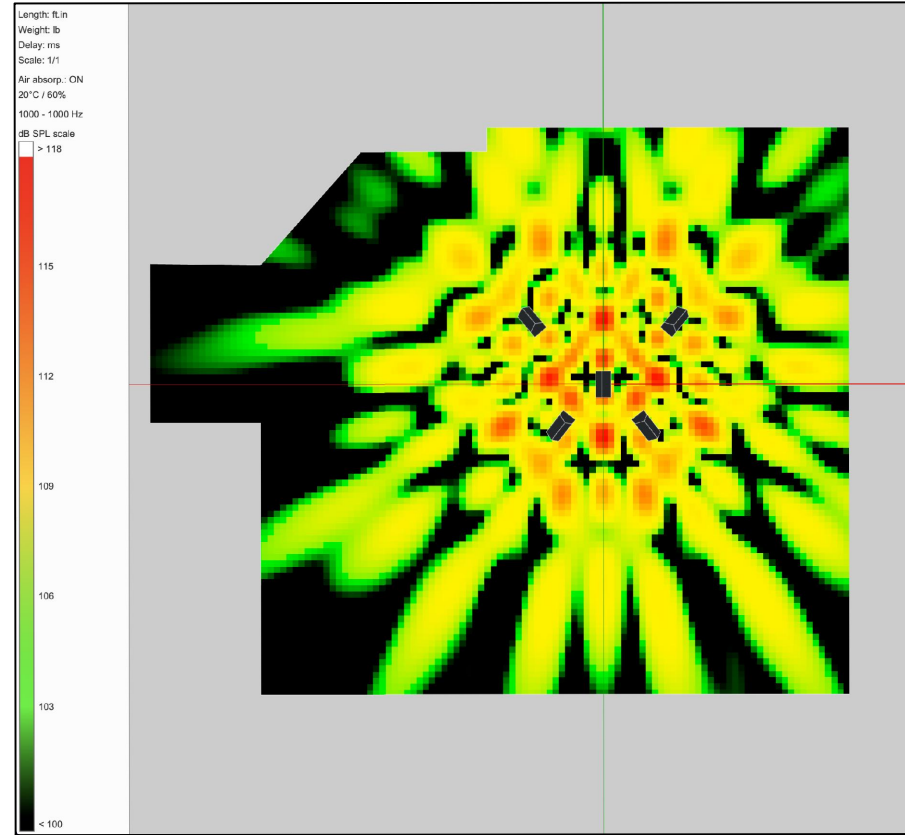

1KHz

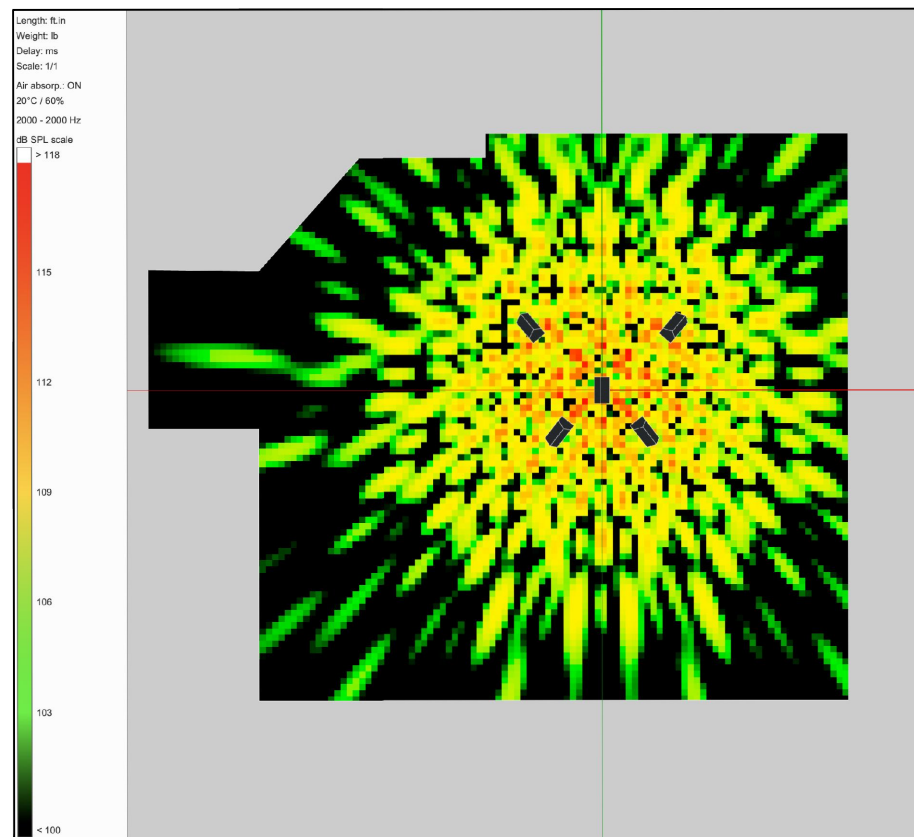

2KHz

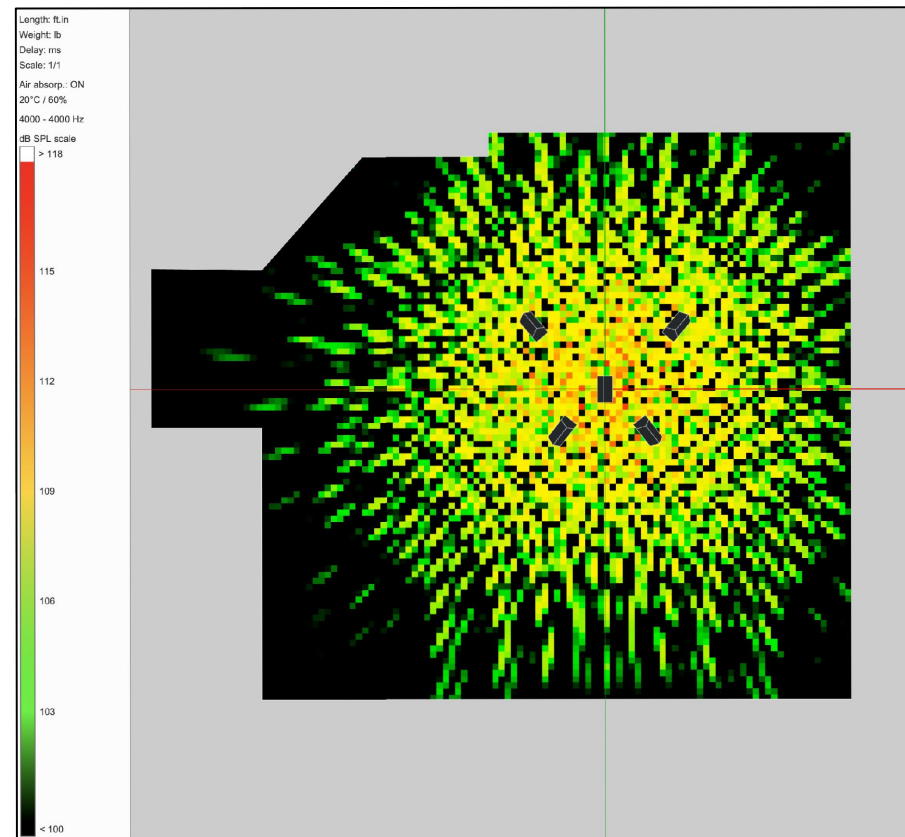

4KHz

SHOW  
Soundscape 2.0

VENUE  
UNCSA Library

DESIGNER  
NORA CUTHBERTSON

DRAFTER  
MATTHEW KUPFERER

NOTES

TITLE  
OH  
COVERAGE

PLATE  
13  
22

DATE  
4-Apr-22

SCALE  
NO SCALE

FILENAME  
SOUNDSCAPE 3-25-AS.DWG

SHOW  
Soundscape 2.0

VENUE  
UNCSA Library

DESIGNER  
NORA CUTHBERTSON

DRAFTER  
MATTHEW KUPFERER

NOTES

Team  
Member Nora Cuthbertson  
Budget  
Weekly Hours 25:00  
Start Date 1/10/22

Week 1	Date	Planned 1st Call Start	Planned 1st Call Stop	Hours	Break	Planned 2nd Call Start	Planned 2nd Call Stop	Hours	Break	Planned 3rd Call Start	Planned 3rd Call Stop	Hours	Planned Total	Actual 1st Call Start	Actual 1st Call Stop	Hours	Break	Actual 2nd Call Start	Actual 2nd Call Stop	Hours	Break	Actual 3rd Call Start	Actual 3rd Call Stop	Hours	Actual Total
Monday	1/10/22			0:00	0:00			0:00	0:00			0:00	0:00			0:00	0:00			0:00	0:00			0:00	0:00
Tuesday	1/11/22			0:00	0:00			0:00	0:00			0:00	0:00			0:00	0:00			0:00	0:00			0:00	0:00
Wednesday	1/12/22 L-ISA Overview			0:00	0:00			0:00	0:00			0:00	0:00	2:00 PM	3:00 PM	1:00	0:00			0:00	0:00			0:00	1:00
Thursday	1/13/22			0:00	0:00			0:00	0:00			0:00	0:00			0:00	0:00			0:00	0:00			0:00	0:00
Friday	1/14/22			0:00	0:00			0:00	0:00			0:00	0:00			0:00	0:00			0:00	0:00			0:00	0:00
Saturday	1/15/22			0:00	0:00			0:00	0:00			0:00	0:00			0:00	0:00			0:00	0:00			0:00	0:00
Sunday	1/16/22			0:00	0:00			0:00	0:00			0:00	0:00			0:00	0:00			0:00	0:00			0:00	0:00
													Planned Weekly Total												0:00
													Planned Weekly Average												0:00
																								Actual Weekly Total	1:00
																								Actual Weekly Average	1:00

Week 2	Date	Planned 1st Call Start	Planned 1st Call Stop	Hours	Break	Planned 2nd Call Start	Planned 2nd Call Stop	Hours	Break	Planned 3rd Call Start	Planned 3rd Call Stop	Hours	Planned Total	Actual 1st Call Start	Actual 1st Call Stop	Hours	Break	Actual 2nd Call Start	Actual 2nd Call Stop	Hours	Break	Actual 3rd Call Start	Actual 3rd Call Stop	Hours	Actual Total
Monday	1/17/22 Drafting, paperwork			0:00	0:00			0:00	0:00			0:00	0:00			0:00	0:00			0:00	0:00			0:00	0:00
Tuesday	1/18/22			0:00	0:00			0:00	0:00			0:00	0:00			0:00	0:00			0:00	0:00			0:00	0:00
Wednesday	1/19/22 First paperwork look, load in	2:00 PM	6:00 PM	4:00	0:00			0:00	0:00			0:00	4:00			0:00	0:00			0:00	0:00			0:00	0:00
Thursday	1/20/22 Load In	7:00 PM	11:00 PM	4:00	0:00			0:00	0:00			0:00	4:00			0:00	0:00			0:00	0:00			0:00	0:00
Friday	1/21/22 Load In	2:00 PM	6:00 PM	4:00	0:00			0:00	0:00			0:00	4:00	2:00 PM	5:00 PM	3:00	0:00			0:00	0:00			0:00	3:00
Saturday	1/22/22			0:00	0:00			0:00	0:00			0:00	0:00			0:00	0:00			0:00	0:00			0:00	0:00
Sunday	1/23/22			0:00	0:00			0:00	0:00			0:00	0:00			0:00	0:00			0:00	0:00			0:00	0:00
													Planned Weekly Total												12:00
													Planned Weekly Average												6:00
																								Actual Weekly Total	3:00
																								Actual Weekly Average	2:00

Week 3	Date	Planned 1st Call Start	Planned 1st Call Stop	Hours	Break	Planned 2nd Call Start	Planned 2nd Call Stop	Hours	Break	Planned 3rd Call Start	Planned 3rd Call Stop	Hours	Planned Total	Actual 1st Call Start	Actual 1st Call Stop	Hours	Break	Actual 2nd Call Start	Actual 2nd Call Stop	Hours	Break	Actual 3rd Call Start	Actual 3rd Call Stop	Hours	Actual Total
Monday	1/24/22 Shop advising, load in	2:00 PM	6:00 PM	4:00	0:00			0:00	0:00			0:00	4:00	2:00 PM	6:00 PM	4:00	0:00			0:00	0:00			0:00	4:00
Tuesday	1/25/22 Load in	7:00 PM	11:00 PM	4:00	0:00			0:00	0:00			0:00	4:00	7:00 PM	11:00 PM	4:00	0:00			0:00	0:00			0:00	4:00
Wednesday	1/26/22 Final shop advising	2:00 PM	6:00 PM	4:00	0:00			0:00	0:00			0:00	4:00			0:00	0:00			0:00	0:00			0:00	0:00
Thursday	1/27/22			0:00	0:00			0:00	0:00			0:00	0:00			0:00	0:00			0:00	0:00			0:00	0:00
Friday	1/28/22			0:00	0:00			0:00	0:00			0:00	0:00			0:00	0:00			0:00	0:00			0:00	0:00
Saturday	1/29/22			0:00	0:00			0:00	0:00			0:00	0:00			0:00	0:00			0:00	0:00			0:00	0:00
Sunday	1/30/22			0:00	0:00			0:00	0:00			0:00	0:00			0:00	0:00			0:00	0:00			0:00	0:00
													Planned Weekly Total												12:00
													Planned Weekly Average												8:00
																								Actual Weekly Total	8:00
																								Actual Weekly Average	4:00

Week 4	Date	Planned 1st Call Start	Planned 1st Call Stop	Hours	Break	Planned 2nd Call Start	Planned 2nd Call Stop	Hours	Break	Planned 3rd Call Start	Planned 3rd Call Stop	Hours	Planned Total	Actual 1st Call Start	Actual 1st Call Stop	Hours	Break	Actual 2nd Call Start	Actual 2nd Call Stop	Hours	Break	Actual 3rd Call Start	Actual 3rd Call Stop	Hours	Actual Total
Monday	1/31/22 Finalize paperwork	2:00 PM	6:00 PM	4:00	0:00			0:00	0:00			0:00	4:00			0:00	0:00			0:00	0:00			0:00	0:00
Tuesday	2/1/22			0:00	0:00			0:00	0:00			0:00	0:00			0:00	0:00			0:00	0:00			0:00	0:00
Wednesday	2/2/22 Final paperwork look	2:00 PM	3:00 PM	1:00	0:00			0:00	0:00			0:00	1:00			0:00	0:00			0:00	0:00			0:00	0:00
Thursday	2/3/22			0:00	0:00			0:00	0:00			0:00	0:00			0:00	0:00			0:00	0:00			0:00	0:00
Friday	2/4/22			0:00	0:00			0:00	0:00			0:00	0:00			0:00	0:00			0:00	0:00			0:00	0:00

TITLE  
NORA  
TIMESHEET

PLATE

14  
22

DATE 4-Apr-22 SCALE NO SCALE

FILENAME SOUNDSCAPE 3-25-AS.DWG



SHOW  
Soundscape 2.0

VENUE  
UNCSA Library

DESIGNER  
NORA CUTHBERTSON

DRAFTER  
MATTHEW KUPFERER

NOTES

Saturday	2/5/22			0:00	0:00			0:00	0:00			0:00	0:00			0:00	0:00			0:00	0:00			0:00	0:00
Sunday	2/6/22			0:00	0:00			0:00	0:00			0:00	0:00			0:00	0:00			0:00	0:00			0:00	0:00
													Planned Weekly Total												5:00
													Planned Weekly Average												7:15
																								Actual Weekly Total	0:00
																								Actual Weekly Average	3:00

Week 5	Date	Planned 1st Call Start	Planned 1st Call Stop	Hours	Break	Planned 2nd Call Start	Planned 2nd Call Stop	Hours	Break	Planned 3rd Call Start	Planned 3rd Call Stop	Hours	Planned Total	Actual 1st Call Start	Actual 1st Call Stop	Hours	Break	Actual 2nd Call Start	Actual 2nd Call Stop	Hours	Break	Actual 3rd Call Start	Actual 3rd Call Stop	Hours	Actual Total
Monday	2/7/22			0:00	0:00			0:00	0:00			0:00	0:00			0:00	0:00			0:00	0:00			0:00	0:00
Tuesday	2/8/22			0:00	0:00			0:00	0:00			0:00	0:00			0:00	0:00			0:00	0:00			0:00	0:00
Wednesday	2/9/22			0:00	0:00			0:00	0:00			0:00	0:00			0:00	0:00			0:00	0:00			0:00	0:00
Thursday	2/10/22 L-ISA Training			0:00	0:00			0:00	0:00			0:00	0:00	1:00 PM	5:30 PM	4:30	0:00			0:00	0:00			0:00	4:30
Friday	2/11/22 L-ISA Training			0:00	0:00			0:00	0:00			0:00	0:00	9:00 AM	12:30 PM	3:30	1:00	1:30 PM	4:30 PM	3:00	0:00			0:00	6:30
Saturday	2/12/22			0:00	0:00			0:00	0:00			0:00	0:00			0:00	0:00			0:00	0:00			0:00	0:00
Sunday	2/13/22			0:00	0:00			0:00	0:00			0:00	0:00			0:00	0:00			0:00	0:00			0:00	0:00
													Planned Weekly Total												0:00
													Planned Weekly Average												5:48
																								Actual Weekly Total	11:00
																								Actual Weekly Average	4:36

Week 6	Date	Planned 1st Call Start	Planned 1st Call Stop	Hours	Break	Planned 2nd Call Start	Planned 2nd Call Stop	Hours	Break	Planned 3rd Call Start	Planned 3rd Call Stop	Hours	Planned Total	Actual 1st Call Start	Actual 1st Call Stop	Hours	Break	Actual 2nd Call Start	Actual 2nd Call Stop	Hours	Break	Actual 3rd Call Start	Actual 3rd Call Stop	Hours	Actual Total
Monday	2/14/22			0:00	0:00			0:00	0:00			0:00	0:00			0:00	0:00			0:00	0:00			0:00	0:00
Tuesday	2/15/22			0:00	0:00			0:00	0:00			0:00	0:00			0:00	0:00			0:00	0:00			0:00	0:00
Wednesday	2/16/22			0:00	0:00			0:00	0:00			0:00	0:00			0:00	0:00			0:00	0:00			0:00	0:00
Thursday	2/17/22			0:00	0:00			0:00	0:00			0:00	0:00			0:00	0:00			0:00	0:00			0:00	0:00
Friday	2/18/22			0:00	0:00			0:00	0:00			0:00	0:00			0:00	0:00			0:00	0:00			0:00	0:00
Saturday	2/19/22			0:00	0:00			0:00	0:00			0:00	0:00			0:00	0:00			0:00	0:00			0:00	0:00
Sunday	2/20/22			0:00	0:00			0:00	0:00			0:00	0:00			0:00	0:00			0:00	0:00			0:00	0:00
													Planned Weekly Total												0:00
													Planned Weekly Average												4:50
																								Actual Weekly Total	0:00
																								Actual Weekly Average	3:50

Week 7	Date	Planned 1st Call Start	Planned 1st Call Stop	Hours	Break	Planned 2nd Call Start	Planned 2nd Call Stop	Hours	Break	Planned 3rd Call Start	Planned 3rd Call Stop	Hours	Planned Total	Actual 1st Call Start	Actual 1st Call Stop	Hours	Break	Actual 2nd Call Start	Actual 2nd Call Stop	Hours	Break	Actual 3rd Call Start	Actual 3rd Call Stop	Hours	Actual Total
Monday	2/21/22			0:00	0:00			0:00	0:00			0:00	0:00			0:00	0:00			0:00	0:00			0:00	0:00
Tuesday	2/22/22			0:00	0:00			0:00	0:00			0:00	0:00			0:00	0:00			0:00	0:00			0:00	0:00
Wednesday	2/23/22			0:00	0:00			0:00	0:00			0:00	0:00			0:00	0:00			0:00	0:00			0:00	0:00
Thursday	2/24/22			0:00	0:00			0:00	0:00			0:00	0:00			0:00	0:00			0:00	0:00			0:00	0:00
Friday	2/25/22			0:00	0:00			0:00	0:00			0:00	0:00			0:00	0:00			0:00	0:00			0:00	0:00
Saturday	2/26/22			0:00	0:00			0:00	0:00			0:00	0:00			0:00	0:00			0:00	0:00			0:00	0:00
Sunday	2/27/22			0:00	0:00			0:00	0:00			0:00	0:00			0:00	0:00			0:00	0:00			0:00	0:00
													Planned Weekly Total												0:00
													Planned Weekly Average												4:08
																								Actual Weekly Total	0:00
																								Actual Weekly Average	3:17

Week 8	Date	Planned 1st Call Start	Planned 1st Call Stop	Hours	Break	Planned 2nd Call Start	Planned 2nd Call Stop	Hours	Break	Planned 3rd Call Start	Planned 3rd Call Stop	Hours	Planned Total	Actual 1st Call Start	Actual 1st Call Stop	Hours	Break	Actual 2nd Call Start	Actual 2nd Call Stop	Hours	Break	Actual 3rd Call Start	Actual 3rd Call Stop	Hours	Actual Total
Monday	2/28/22 Setting up longer pipes			0:00	0:00			0:00	0:00			0:00	0:00	2:00 PM	3:00 PM	1:00	0:00			0:00	0:00			0:00	1:00
Tuesday	3/1/22			0:00	0:00			0:00	0:00			0:00	0:00			0:00	0:00			0:00	0:00			0:00	0:00
Wednesday	3/2/22			0:00	0:00			0:00	0:00			0:00	0:00			0:00	0:00			0:00	0:00			0:00	0:00
Thursday	3/3/22			0:00	0:00			0:00	0:00			0:00	0:00			0:00	0:00			0:00	0:00			0:00	0:00

TITLE  
NORA  
TIMESHEET

PLATE

15  
22

DATE  
4-Apr-22

SCALE  
NO SCALE

FILENAME  
SOUNDSCAPE 3-25-AS.DWG

SHOW  
Soundscape 2.0

VENUE  
UNCSA Library

DESIGNER  
NORA CUTHBERTSON

DRAFTER  
MATTHEW KUPFERER

NOTES

Friday	3/4/22			0:00	0:00			0:00	0:00			0:00	0:00			0:00	0:00			0:00	0:00			0:00	0:00
Saturday	3/5/22			0:00	0:00			0:00	0:00			0:00	0:00			0:00	0:00			0:00	0:00			0:00	0:00
Sunday	3/6/22			0:00	0:00			0:00	0:00			0:00	0:00			0:00	0:00			0:00	0:00			0:00	0:00
													Planned Weekly Total												0:00
													Planned Weekly Average												3:37
																								Actual Weekly Total	1:00
																								Actual Weekly Average	3:00

Week 9	Date	Planned 1st Call Start	Planned 1st Call Stop	Hours	Break	Planned 2nd Call Start	Planned 2nd Call Stop	Hours	Break	Planned 3rd Call Start	Planned 3rd Call Stop	Hours	Planned Total	Actual 1st Call Start	Actual 1st Call Stop	Hours	Break	Actual 2nd Call Start	Actual 2nd Call Stop	Hours	Break	Actual 3rd Call Start	Actual 3rd Call Stop	Hours	Actual Total
Monday	3/7/22			0:00	0:00			0:00	0:00			0:00	0:00			0:00	0:00			0:00	0:00			0:00	0:00
Tuesday	3/8/22			0:00	0:00			0:00	0:00			0:00	0:00			0:00	0:00			0:00	0:00			0:00	0:00
Wednesday	3/9/22			0:00	0:00			0:00	0:00			0:00	0:00			0:00	0:00			0:00	0:00			0:00	0:00
Thursday	3/10/22			0:00	0:00			0:00	0:00			0:00	0:00			0:00	0:00			0:00	0:00			0:00	0:00
Friday	3/11/22			0:00	0:00			0:00	0:00			0:00	0:00			0:00	0:00			0:00	0:00			0:00	0:00
Saturday	3/12/22			0:00	0:00			0:00	0:00			0:00	0:00			0:00	0:00			0:00	0:00			0:00	0:00
Sunday	3/13/22			0:00	0:00			0:00	0:00			0:00	0:00			0:00	0:00			0:00	0:00			0:00	0:00
													Planned Weekly Total												0:00
													Planned Weekly Average												3:13
																								Actual Weekly Total	0:00
																								Actual Weekly Average	2:40

Week 10	Date	Planned 1st Call Start	Planned 1st Call Stop	Hours	Break	Planned 2nd Call Start	Planned 2nd Call Stop	Hours	Break	Planned 3rd Call Start	Planned 3rd Call Stop	Hours	Planned Total	Actual 1st Call Start	Actual 1st Call Stop	Hours	Break	Actual 2nd Call Start	Actual 2nd Call Stop	Hours	Break	Actual 3rd Call Start	Actual 3rd Call Stop	Hours	Actual Total
Monday	3/14/22			0:00	0:00			0:00	0:00			0:00	0:00			0:00	0:00			0:00	0:00			0:00	0:00
Tuesday	3/15/22			0:00	0:00			0:00	0:00			0:00	0:00			0:00	0:00			0:00	0:00			0:00	0:00
Wednesday	3/16/22			0:00	0:00			0:00	0:00			0:00	0:00			0:00	0:00			0:00	0:00			0:00	0:00
Thursday	3/17/22			0:00	0:00			0:00	0:00			0:00	0:00			0:00	0:00			0:00	0:00			0:00	0:00
Friday	3/18/22			0:00	0:00			0:00	0:00			0:00	0:00			0:00	0:00			0:00	0:00			0:00	0:00
Saturday	3/19/22			0:00	0:00			0:00	0:00			0:00	0:00			0:00	0:00			0:00	0:00			0:00	0:00
Sunday	3/20/22	Soundscape Programming		0:00	0:00			0:00	0:00			0:00	0:00	1:00 PM	5:00 PM	4:00	0:00			0:00	0:00			0:00	4:00
													Planned Weekly Total												0:00
													Planned Weekly Average												2:54
																								Actual Weekly Total	4:00
																								Actual Weekly Average	2:48

Week 11	Date	Planned 1st Call Start	Planned 1st Call Stop	Hours	Break	Planned 2nd Call Start	Planned 2nd Call Stop	Hours	Break	Planned 3rd Call Start	Planned 3rd Call Stop	Hours	Planned Total	Actual 1st Call Start	Actual 1st Call Stop	Hours	Break	Actual 2nd Call Start	Actual 2nd Call Stop	Hours	Break	Actual 3rd Call Start	Actual 3rd Call Stop	Hours	Actual Total
Monday	3/21/22	Soundscape Programming		0:00	0:00			0:00	0:00			0:00	0:00	2:00 PM	6:00 PM	4:00	0:00			0:00	0:00			0:00	4:00
Tuesday	3/22/22	Soundscape Programming		0:00	0:00			0:00	0:00			0:00	0:00	7:00 PM	11:00 PM	4:00	0:00			0:00	0:00			0:00	4:00
Wednesday	3/23/22	Soundscape Programming		0:00	0:00			0:00	0:00			0:00	0:00	2:00 PM	6:00 PM	4:00	0:00			0:00	0:00			0:00	4:00
Thursday	3/24/22	Soundscape Programming		0:00	0:00			0:00	0:00			0:00	0:00	7:00 PM	11:00 PM	4:00	0:00			0:00	0:00			0:00	4:00
Friday	3/25/22	Soundscape Programming		0:00	0:00			0:00	0:00			0:00	0:00	2:00 PM	6:00 PM	4:00	0:00			0:00	0:00			0:00	4:00
Saturday	3/26/22			0:00	0:00			0:00	0:00			0:00	0:00			0:00	0:00			0:00	0:00			0:00	0:00
Sunday	3/27/22			0:00	0:00			0:00	0:00			0:00	0:00			0:00	0:00			0:00	0:00			0:00	0:00
													Planned Weekly Total												0:00
													Planned Weekly Average												2:38
																								Actual Weekly Total	20:00
																								Actual Weekly Average	4:21

TITLE  
NORA  
TIMESHEET

PLATE

16  
22

DATE  
4-Apr-22

SCALE  
NO SCALE

FILENAME  
SOUNDSCAPE 3-25-AS.DWG



SHOW  
Soundscape 2.0

VENUE  
UNCSA Library

DESIGNER  
NORA CUTHBERTSON

DRAFTER  
MATTHEW KUPFERER

NOTES

Team  
Member Matthew Kupferer  
Budget  
Weekly Hours 25:00  
Start Date 1/10/22

Week 1	Date	Planned 1st Call Start	Planned 1st Call Stop	Hours	Break	Planned 2nd Call Start	Planned 2nd Call Stop	Hours	Break	Planned 3rd Call Start	Planned 3rd Call Stop	Hours	Planned Total	Actual 1st Call Start	Actual 1st Call Stop	Hours	Break	Actual 2nd Call Start	Actual 2nd Call Stop	Hours	Break	Actual 3rd Call Start	Actual 3rd Call Stop	Hours	Actual Total
Monday	1/10/22			0:00	0:00			0:00	0:00			0:00	0:00	11:00 PM	12:30 AM	1:30	0:00			0:00	0:00			0:00	1:30
Tuesday	1/11/22			0:00	0:00			0:00	0:00			0:00	0:00			0:00	0:00			0:00	0:00			0:00	0:00
Wednesday	1/12/22			0:00	0:00			0:00	0:00			0:00	0:00	2:00 PM	4:00 PM	2:00	2:00	6:00 PM	8:00 PM	2:00	0:00			0:00	4:00
Thursday	1/13/22			0:00	0:00			0:00	0:00			0:00	0:00	5:00 PM	6:30 PM	1:30	4:30	11:00 PM	1:30 AM	2:30	0:00			0:00	4:00
Friday	1/14/22			0:00	0:00			0:00	0:00			0:00	0:00			0:00	0:00			0:00	0:00			0:00	0:00
Saturday	1/15/22			0:00	0:00			0:00	0:00			0:00	0:00	10:30 AM	1:00 PM	2:30	1:30	2:30 PM	5:30 PM	3:00	4:30	10:00 PM	2:30 AM	4:30	10:00
Sunday	1/16/22			0:00	0:00			0:00	0:00			0:00	0:00	10:00 PM	1:00 AM	3:00	0:00			0:00	0:00			0:00	3:00
													Planned Weekly Total				0:00				Actual Weekly Total				22:30
													Planned Weekly Average				0:00				Actual Weekly Average				22:30

Week 2	Date	Planned 1st Call Start	Planned 1st Call Stop	Hours	Break	Planned 2nd Call Start	Planned 2nd Call Stop	Hours	Break	Planned 3rd Call Start	Planned 3rd Call Stop	Hours	Planned Total	Actual 1st Call Start	Actual 1st Call Stop	Hours	Break	Actual 2nd Call Start	Actual 2nd Call Stop	Hours	Break	Actual 3rd Call Start	Actual 3rd Call Stop	Hours	Actual Total
Monday	1/17/22			0:00	0:00			0:00	0:00			0:00	0:00			0:00	0:00			0:00	0:00			0:00	0:00
Tuesday	1/18/22			0:00	0:00			0:00	0:00			0:00	0:00			0:00	0:00			0:00	0:00			0:00	0:00
Wednesday	1/19/22	2:00 PM	6:00 PM	4:00	0:00			0:00	0:00			0:00	4:00	2:00 PM	6:00 PM	4:00	0:00			0:00	0:00			0:00	4:00
Thursday	1/20/22	7:00 PM	11:00 PM	4:00	0:00			0:00	0:00			0:00	4:00			0:00	0:00			0:00	0:00			0:00	0:00
Friday	1/21/22	2:00 PM	6:00 PM	4:00	0:00			0:00	0:00			0:00	4:00	2:00 PM	5:00 PM	3:00	0:00			0:00	0:00			0:00	3:00
Saturday	1/22/22			0:00	0:00			0:00	0:00			0:00	0:00			0:00	0:00			0:00	0:00			0:00	0:00
Sunday	1/23/22			0:00	0:00			0:00	0:00			0:00	0:00			0:00	0:00			0:00	0:00			0:00	0:00
													Planned Weekly Total				12:00				Actual Weekly Total				7:00
													Planned Weekly Average				6:00				Actual Weekly Average				14:45

Week 3	Date	Planned 1st Call Start	Planned 1st Call Stop	Hours	Break	Planned 2nd Call Start	Planned 2nd Call Stop	Hours	Break	Planned 3rd Call Start	Planned 3rd Call Stop	Hours	Planned Total	Actual 1st Call Start	Actual 1st Call Stop	Hours	Break	Actual 2nd Call Start	Actual 2nd Call Stop	Hours	Break	Actual 3rd Call Start	Actual 3rd Call Stop	Hours	Actual Total
Monday	1/24/22	2:00 PM	6:00 PM	4:00	0:00			0:00	0:00			0:00	4:00	2:00 PM	6:00 PM	4:00	0:00			0:00	0:00			0:00	4:00
Tuesday	1/25/22	7:00 PM	11:00 PM	4:00	0:00			0:00	0:00			0:00	4:00	7:00 PM	11:00 PM	4:00	0:00			0:00	0:00			0:00	4:00
Wednesday	1/26/22	2:00 PM	6:00 PM	4:00	0:00			0:00	0:00			0:00	4:00	2:00 PM	3:00 PM	1:00	0:00			0:00	0:00			0:00	1:00
Thursday	1/27/22			0:00	0:00			0:00	0:00			0:00	0:00			0:00	0:00			0:00	0:00			0:00	0:00
Friday	1/28/22			0:00	0:00			0:00	0:00			0:00	0:00			0:00	0:00			0:00	0:00			0:00	0:00
Saturday	1/29/22			0:00	0:00			0:00	0:00			0:00	0:00			0:00	0:00			0:00	0:00			0:00	0:00
Sunday	1/30/22			0:00	0:00			0:00	0:00			0:00	0:00			0:00	0:00			0:00	0:00			0:00	0:00
													Planned Weekly Total				12:00				Actual Weekly Total				9:00
													Planned Weekly Average				8:00				Actual Weekly Average				12:50

Week 4	Date	Planned 1st Call Start	Planned 1st Call Stop	Hours	Break	Planned 2nd Call Start	Planned 2nd Call Stop	Hours	Break	Planned 3rd Call Start	Planned 3rd Call Stop	Hours	Planned Total	Actual 1st Call Start	Actual 1st Call Stop	Hours	Break	Actual 2nd Call Start	Actual 2nd Call Stop	Hours	Break	Actual 3rd Call Start	Actual 3rd Call Stop	Hours	Actual Total
Monday	1/31/22	2:00 PM	6:00 PM	4:00	0:00			0:00	0:00			0:00	4:00			0:00	0:00			0:00	0:00			0:00	0:00
Tuesday	2/1/22			0:00	0:00			0:00	0:00			0:00	0:00			0:00	0:00			0:00	0:00			0:00	0:00
Wednesday	2/2/22	2:00 PM	3:00 PM	1:00	0:00			0:00	0:00			0:00	1:00			0:00	0:00			0:00	0:00			0:00	0:00
Thursday	2/3/22			0:00	0:00			0:00	0:00			0:00	0:00			0:00	0:00			0:00	0:00			0:00	0:00
Friday	2/4/22			0:00	0:00			0:00	0:00			0:00	0:00			0:00	0:00			0:00	0:00			0:00	0:00

TITLE  
MATTHEW  
TIMESHEET

PLATE

17  
22

DATE 4-Apr-22 SCALE NO SCALE

FILENAME SOUNDSCAPE 3-25-AS.DWG

SHOW  
Soundscape 2.0

VENUE  
UNCSA Library

DESIGNER  
NORA CUTHBERTSON

DRAFTER  
MATTHEW KUPFERER

NOTES

Saturday	2/5/22			0:00	0:00			0:00	0:00			0:00	0:00			0:00	0:00			0:00	0:00			0:00	0:00
Sunday	2/6/22			0:00	0:00			0:00	0:00			0:00	0:00			0:00	0:00			0:00	0:00			0:00	0:00
													Planned Weekly Total											Actual Weekly Total	0:00
													Planned Weekly Average											Actual Weekly Average	9:37

Week 5	Date	Planned 1st Call Start	Planned 1st Call Stop	Hours	Break	Planned 2nd Call Start	Planned 2nd Call Stop	Hours	Break	Planned 3rd Call Start	Planned 3rd Call Stop	Hours	Planned Total	Actual 1st Call Start	Actual 1st Call Stop	Hours	Break	Actual 2nd Call Start	Actual 2nd Call Stop	Hours	Break	Actual 3rd Call Start	Actual 3rd Call Stop	Hours	Actual Total
Monday	2/7/22			0:00	0:00			0:00	0:00			0:00	0:00			0:00	0:00			0:00	0:00			0:00	0:00
Tuesday	2/8/22			0:00	0:00			0:00	0:00			0:00	0:00			0:00	0:00			0:00	0:00			0:00	0:00
Wednesday	2/9/22			0:00	0:00			0:00	0:00			0:00	0:00			0:00	0:00			0:00	0:00			0:00	0:00
Thursday	2/10/22 L-ISA Training			0:00	0:00			0:00	0:00			0:00	0:00	1:00 PM	5:30 PM	4:30	0:00			0:00	0:00			0:00	4:30
Friday	2/11/22 L-ISA Training			0:00	0:00			0:00	0:00			0:00	0:00	9:00 AM	12:30 PM	3:30	1:00	1:30 PM	4:30 PM	3:00	0:00			0:00	6:30
Saturday	2/12/22			0:00	0:00			0:00	0:00			0:00	0:00			0:00	0:00			0:00	0:00			0:00	0:00
Sunday	2/13/22			0:00	0:00			0:00	0:00			0:00	0:00			0:00	0:00			0:00	0:00			0:00	0:00
													Planned Weekly Total											Actual Weekly Total	11:00
													Planned Weekly Average											Actual Weekly Average	9:54

Week 6	Date	Planned 1st Call Start	Planned 1st Call Stop	Hours	Break	Planned 2nd Call Start	Planned 2nd Call Stop	Hours	Break	Planned 3rd Call Start	Planned 3rd Call Stop	Hours	Planned Total	Actual 1st Call Start	Actual 1st Call Stop	Hours	Break	Actual 2nd Call Start	Actual 2nd Call Stop	Hours	Break	Actual 3rd Call Start	Actual 3rd Call Stop	Hours	Actual Total
Monday	2/14/22			0:00	0:00			0:00	0:00			0:00	0:00			0:00	0:00			0:00	0:00			0:00	0:00
Tuesday	2/15/22			0:00	0:00			0:00	0:00			0:00	0:00			0:00	0:00			0:00	0:00			0:00	0:00
Wednesday	2/16/22			0:00	0:00			0:00	0:00			0:00	0:00			0:00	0:00			0:00	0:00			0:00	0:00
Thursday	2/17/22			0:00	0:00			0:00	0:00			0:00	0:00			0:00	0:00			0:00	0:00			0:00	0:00
Friday	2/18/22			0:00	0:00			0:00	0:00			0:00	0:00			0:00	0:00			0:00	0:00			0:00	0:00
Saturday	2/19/22			0:00	0:00			0:00	0:00			0:00	0:00			0:00	0:00			0:00	0:00			0:00	0:00
Sunday	2/20/22			0:00	0:00			0:00	0:00			0:00	0:00			0:00	0:00			0:00	0:00			0:00	0:00
													Planned Weekly Total											Actual Weekly Total	0:00
													Planned Weekly Average											Actual Weekly Average	8:15

Week 7	Date	Planned 1st Call Start	Planned 1st Call Stop	Hours	Break	Planned 2nd Call Start	Planned 2nd Call Stop	Hours	Break	Planned 3rd Call Start	Planned 3rd Call Stop	Hours	Planned Total	Actual 1st Call Start	Actual 1st Call Stop	Hours	Break	Actual 2nd Call Start	Actual 2nd Call Stop	Hours	Break	Actual 3rd Call Start	Actual 3rd Call Stop	Hours	Actual Total
Monday	2/21/22			0:00	0:00			0:00	0:00			0:00	0:00			0:00	0:00			0:00	0:00			0:00	0:00
Tuesday	2/22/22			0:00	0:00			0:00	0:00			0:00	0:00			0:00	0:00			0:00	0:00			0:00	0:00
Wednesday	2/23/22			0:00	0:00			0:00	0:00			0:00	0:00			0:00	0:00			0:00	0:00			0:00	0:00
Thursday	2/24/22			0:00	0:00			0:00	0:00			0:00	0:00			0:00	0:00			0:00	0:00			0:00	0:00
Friday	2/25/22 Prepping for longer pipes			0:00	0:00			0:00	0:00			0:00	0:00	2:00 PM	4:00 PM	2:00	0:00			0:00	0:00			0:00	2:00
Saturday	2/26/22			0:00	0:00			0:00	0:00			0:00	0:00			0:00	0:00			0:00	0:00			0:00	0:00
Sunday	2/27/22			0:00	0:00			0:00	0:00			0:00	0:00			0:00	0:00			0:00	0:00			0:00	0:00
													Planned Weekly Total											Actual Weekly Total	2:00
													Planned Weekly Average											Actual Weekly Average	7:21

Week 8	Date	Planned 1st Call Start	Planned 1st Call Stop	Hours	Break	Planned 2nd Call Start	Planned 2nd Call Stop	Hours	Break	Planned 3rd Call Start	Planned 3rd Call Stop	Hours	Planned Total	Actual 1st Call Start	Actual 1st Call Stop	Hours	Break	Actual 2nd Call Start	Actual 2nd Call Stop	Hours	Break	Actual 3rd Call Start	Actual 3rd Call Stop	Hours	Actual Total
Monday	2/28/22 Setting up longer pipes			0:00	0:00			0:00	0:00			0:00	0:00	2:00 PM	3:00 PM	1:00	0:00			0:00	0:00			0:00	1:00
Tuesday	3/1/22			0:00	0:00			0:00	0:00			0:00	0:00			0:00	0:00			0:00	0:00			0:00	0:00
Wednesday	3/2/22			0:00	0:00			0:00	0:00			0:00	0:00			0:00	0:00			0:00	0:00			0:00	0:00
Thursday	3/3/22			0:00	0:00			0:00	0:00			0:00	0:00			0:00	0:00			0:00	0:00			0:00	0:00
Friday	3/4/22			0:00	0:00			0:00	0:00			0:00	0:00			0:00	0:00			0:00	0:00			0:00	0:00

TITLE  
MATTHEW  
TIMESHEET

PLATE

18  
22

DATE  
4-Apr-22

SCALE  
NO SCALE

FILENAME  
SOUNDSCAPE 3-25-AS.DWG



Wednesday	3/2/22			0:00	0:00			0:00	0:00			0:00	0:00			0:00	0:00			0:00	0:00			0:00	0:00
Thursday	3/3/22			0:00	0:00			0:00	0:00			0:00	0:00			0:00	0:00			0:00	0:00			0:00	0:00
Friday	3/4/22			0:00	0:00			0:00	0:00			0:00	0:00			0:00	0:00			0:00	0:00			0:00	0:00

SHOW  
Soundscape 2.0

VENUE  
UNCSA Library

DESIGNER  
NORA CUTHBERTSON

DRAFTER  
MATTHEW KUPFERER

NOTES

Saturday	3/5/22			0:00	0:00			0:00	0:00			0:00	0:00			0:00	0:00			0:00	0:00			0:00	0:00
Sunday	3/6/22			0:00	0:00			0:00	0:00			0:00	0:00			0:00	0:00			0:00	0:00			0:00	0:00
													Planned Weekly Total											0:00	
													Planned Weekly Average											3:37	
																							Actual Weekly Total	1:00	
																							Actual Weekly Average	6:33	

Week 9	Date	Planned 1st Call Start	Planned 1st Call Stop	Hours	Break	Planned 2nd Call Start	Planned 2nd Call Stop	Hours	Break	Planned 3rd Call Start	Planned 3rd Call Stop	Hours	Planned Total	Actual 1st Call Start	Actual 1st Call Stop	Hours	Break	Actual 2nd Call Start	Actual 2nd Call Stop	Hours	Break	Actual 3rd Call Start	Actual 3rd Call Stop	Hours	Actual Total
Monday	3/7/22			0:00	0:00			0:00	0:00			0:00	0:00			0:00	0:00			0:00	0:00			0:00	0:00
Tuesday	3/8/22			0:00	0:00			0:00	0:00			0:00	0:00			0:00	0:00			0:00	0:00			0:00	0:00
Wednesday	3/9/22			0:00	0:00			0:00	0:00			0:00	0:00			0:00	0:00			0:00	0:00			0:00	0:00
Thursday	3/10/22			0:00	0:00			0:00	0:00			0:00	0:00			0:00	0:00			0:00	0:00			0:00	0:00
Friday	3/11/22			0:00	0:00			0:00	0:00			0:00	0:00			0:00	0:00			0:00	0:00			0:00	0:00
Saturday	3/12/22			0:00	0:00			0:00	0:00			0:00	0:00			0:00	0:00			0:00	0:00			0:00	0:00
Sunday	3/13/22			0:00	0:00			0:00	0:00			0:00	0:00			0:00	0:00			0:00	0:00			0:00	0:00
													Planned Weekly Total											0:00	
													Planned Weekly Average											3:13	
																							Actual Weekly Total	0:00	
																							Actual Weekly Average	5:50	

Week 10	Date	Planned 1st Call Start	Planned 1st Call Stop	Hours	Break	Planned 2nd Call Start	Planned 2nd Call Stop	Hours	Break	Planned 3rd Call Start	Planned 3rd Call Stop	Hours	Planned Total	Actual 1st Call Start	Actual 1st Call Stop	Hours	Break	Actual 2nd Call Start	Actual 2nd Call Stop	Hours	Break	Actual 3rd Call Start	Actual 3rd Call Stop	Hours	Actual Total
Monday	3/14/22			0:00	0:00			0:00	0:00			0:00	0:00			0:00	0:00			0:00	0:00			0:00	0:00
Tuesday	3/15/22			0:00	0:00			0:00	0:00			0:00	0:00			0:00	0:00			0:00	0:00			0:00	0:00
Wednesday	3/16/22			0:00	0:00			0:00	0:00			0:00	0:00			0:00	0:00			0:00	0:00			0:00	0:00
Thursday	3/17/22			0:00	0:00			0:00	0:00			0:00	0:00	2:00 PM	4:00 PM	2:00	0:00			0:00	0:00			0:00	2:00
Friday	3/18/22			0:00	0:00			0:00	0:00			0:00	0:00	12:00 PM	1:30 PM	1:30	0:00			0:00	0:00			0:00	1:30
Saturday	3/19/22			0:00	0:00			0:00	0:00			0:00	0:00	5:00 PM	7:00 PM	2:00	0:00			0:00	0:00			0:00	2:00
Sunday	3/20/22			0:00	0:00			0:00	0:00			0:00	0:00			0:00	0:00			0:00	0:00			0:00	0:00
													Planned Weekly Total											0:00	
													Planned Weekly Average											2:54	
																							Actual Weekly Total	5:30	
																							Actual Weekly Average	5:48	

Week 11	Date	Planned 1st Call Start	Planned 1st Call Stop	Hours	Break	Planned 2nd Call Start	Planned 2nd Call Stop	Hours	Break	Planned 3rd Call Start	Planned 3rd Call Stop	Hours	Planned Total	Actual 1st Call Start	Actual 1st Call Stop	Hours	Break	Actual 2nd Call Start	Actual 2nd Call Stop	Hours	Break	Actual 3rd Call Start	Actual 3rd Call Stop	Hours	Actual Total
Monday	3/21/22			0:00	0:00			0:00	0:00			0:00	0:00	4:30 PM	6:00 PM	1:30	0:00			0:00	0:00			0:00	1:30
Tuesday	3/22/22			0:00	0:00			0:00	0:00			0:00	0:00			0:00	0:00			0:00	0:00			0:00	0:00
Wednesday	3/23/22			0:00	0:00			0:00	0:00			0:00	0:00			0:00	0:00			0:00	0:00			0:00	0:00
Thursday	3/24/22			0:00	0:00			0:00	0:00			0:00	0:00			0:00	0:00			0:00	0:00			0:00	0:00
Friday	3/25/22			0:00	0:00			0:00	0:00			0:00	0:00			0:00	0:00			0:00	0:00			0:00	0:00
Saturday	3/26/22			0:00	0:00			0:00	0:00			0:00	0:00			0:00	0:00			0:00	0:00			0:00	0:00
Sunday	3/27/22			0:00	0:00			0:00	0:00			0:00	0:00			0:00	0:00			0:00	0:00			0:00	0:00
													Planned Weekly Total											0:00	
													Planned Weekly Average											2:38	
																							Actual Weekly Total	1:30	
																							Actual Weekly Average	5:24	

TITLE  
MATTHEW  
TIMESHEET

PLATE

19  
22

Team  
Member Abi Senthil  
Budget  
Weekly Hours 25:00  
Start Date 1/10/22

DATE 4-Apr-22 SCALE NO SCALE

FILENAME SOUNDSCAPE 3-25-AS.DWG

SHOW  
Soundscape 2.0

VENUE  
UNCSA Library

DESIGNER  
NORA CUTHBERTSON

DRAFTER  
MATTHEW KUPFERER

NOTES

Team  
Member Abi Senthil  
Budget  
Weekly Hours 25:00  
Start Date 1/10/22

Week 1	Date	Planned 1st Call Start	Planned 1st Call Stop	Hours	Break	Planned 2nd Call Start	Planned 2nd Call Stop	Hours	Break	Planned 3rd Call Start	Planned 3rd Call Stop	Hours	Planned Total	Actual 1st Call Start	Actual 1st Call Stop	Hours	Break	Actual 2nd Call Start	Actual 2nd Call Stop	Hours	Break	Actual 3rd Call Start	Actual 3rd Call Stop	Hours	Actual Total
Monday	1/10/22			0:00	0:00			0:00	0:00			0:00	0:00			0:00	0:00			0:00	0:00			0:00	0:00
Tuesday	1/11/22			0:00	0:00			0:00	0:00			0:00	0:00			0:00	0:00			0:00	0:00			0:00	0:00
Wednesday	1/12/22 L-ISA Overview			0:00	0:00			0:00	0:00			0:00	0:00	2:00 PM	3:00 PM	1:00	0:00			0:00	0:00			0:00	1:00
Thursday	1/13/22			0:00	0:00			0:00	0:00			0:00	0:00			0:00	0:00			0:00	0:00			0:00	0:00
Friday	1/14/22			0:00	0:00			0:00	0:00			0:00	0:00			0:00	0:00			0:00	0:00			0:00	0:00
Saturday	1/15/22			0:00	0:00			0:00	0:00			0:00	0:00			0:00	0:00			0:00	0:00			0:00	0:00
Sunday	1/16/22			0:00	0:00			0:00	0:00			0:00	0:00			0:00	0:00			0:00	0:00			0:00	0:00
													Planned Weekly Total											0:00	
													Planned Weekly Average											0:00	
																							Actual Weekly Total	1:00	
																							Actual Weekly Average	1:00	

Week 2	Date	Planned 1st Call Start	Planned 1st Call Stop	Hours	Break	Planned 2nd Call Start	Planned 2nd Call Stop	Hours	Break	Planned 3rd Call Start	Planned 3rd Call Stop	Hours	Planned Total	Actual 1st Call Start	Actual 1st Call Stop	Hours	Break	Actual 2nd Call Start	Actual 2nd Call Stop	Hours	Break	Actual 3rd Call Start	Actual 3rd Call Stop	Hours	Actual Total
Monday	1/17/22			0:00	0:00			0:00	0:00			0:00	0:00			0:00	0:00			0:00	0:00			0:00	0:00
Tuesday	1/18/22 Plating paperwork	7:00 PM	11:00 PM	4:00	0:00			0:00	0:00			0:00	4:00	10:00 AM	1:00 PM	3:00	0:00			0:00	0:00			0:00	3:00
Wednesday	1/19/22 First paperwork look, load in	2:00 PM	6:00 PM	4:00	0:00			0:00	0:00			0:00	4:00	2:00 PM	6:00 PM	4:00	0:00			0:00	0:00			0:00	4:00
Thursday	1/20/22 Load In	7:00 PM	11:00 PM	4:00	0:00			0:00	0:00			0:00	4:00			0:00	0:00			0:00	0:00			0:00	0:00
Friday	1/21/22 Load In	2:00 PM	6:00 PM	4:00	0:00			0:00	0:00			0:00	4:00	2:00 PM	5:00 PM	3:00	0:00			0:00	0:00			0:00	3:00
Saturday	1/22/22			0:00	0:00			0:00	0:00			0:00	0:00			0:00	0:00			0:00	0:00			0:00	0:00
Sunday	1/23/22			0:00	0:00			0:00	0:00			0:00	0:00			0:00	0:00			0:00	0:00			0:00	0:00
													Planned Weekly Total											16:00	
													Planned Weekly Average											8:00	
																							Actual Weekly Total	10:00	
																							Actual Weekly Average	5:30	

Week 3	Date	Planned 1st Call Start	Planned 1st Call Stop	Hours	Break	Planned 2nd Call Start	Planned 2nd Call Stop	Hours	Break	Planned 3rd Call Start	Planned 3rd Call Stop	Hours	Planned Total	Actual 1st Call Start	Actual 1st Call Stop	Hours	Break	Actual 2nd Call Start	Actual 2nd Call Stop	Hours	Break	Actual 3rd Call Start	Actual 3rd Call Stop	Hours	Actual Total
Monday	1/24/22 Shop advising, load in	2:00 PM	6:00 PM	4:00	0:00			0:00	0:00			0:00	4:00	2:00 PM	6:00 PM	4:00	0:00			0:00	0:00			0:00	4:00
Tuesday	1/25/22 Load in	7:00 PM	11:00 PM	4:00	0:00			0:00	0:00			0:00	4:00	7:00 PM	11:00 PM	4:00	0:00			0:00	0:00			0:00	4:00
Wednesday	1/26/22 Final shop advising	2:00 PM	6:00 PM	4:00	0:00			0:00	0:00			0:00	4:00	2:00 PM	3:00 PM	1:00	0:00			0:00	0:00			0:00	1:00
Thursday	1/27/22			0:00	0:00			0:00	0:00			0:00	0:00			0:00	0:00			0:00	0:00			0:00	0:00
Friday	1/28/22			0:00	0:00			0:00	0:00			0:00	0:00			0:00	0:00			0:00	0:00			0:00	0:00
Saturday	1/29/22			0:00	0:00			0:00	0:00			0:00	0:00			0:00	0:00			0:00	0:00			0:00	0:00
Sunday	1/30/22			0:00	0:00			0:00	0:00			0:00	0:00			0:00	0:00			0:00	0:00			0:00	0:00
													Planned Weekly Total											12:00	
													Planned Weekly Average											9:20	
																							Actual Weekly Total	9:00	
																							Actual Weekly Average	6:40	

Week 4	Date	Planned 1st Call Start	Planned 1st Call Stop	Hours	Break	Planned 2nd Call Start	Planned 2nd Call Stop	Hours	Break	Planned 3rd Call Start	Planned 3rd Call Stop	Hours	Planned Total	Actual 1st Call Start	Actual 1st Call Stop	Hours	Break	Actual 2nd Call Start	Actual 2nd Call Stop	Hours	Break	Actual 3rd Call Start	Actual 3rd Call Stop	Hours	Actual Total
Monday	1/31/22 Finalize paperwork	2:00 PM	6:00 PM	4:00	0:00			0:00	0:00			0:00	4:00			0:00	0:00			0:00	0:00			0:00	0:00
Tuesday	2/1/22			0:00	0:00			0:00	0:00			0:00	0:00			0:00	0:00			0:00	0:00			0:00	0:00
Wednesday	2/2/22 Final paperwork look	2:00 PM	3:00 PM	1:00	0:00			0:00	0:00			0:00	1:00			0:00	0:00			0:00	0:00			0:00	0:00
Thursday	2/3/22			0:00	0:00			0:00	0:00			0:00	0:00			0:00	0:00			0:00	0:00			0:00	0:00
Friday	2/4/22			0:00	0:00			0:00	0:00			0:00	0:00			0:00	0:00			0:00	0:00			0:00	0:00

TITLE  
ABI  
TIMESHEET

PLATE

20  
22

DATE 4-Apr-22 SCALE NO SCALE

FILENAME SOUNDSCAPE 3-25-AS.DWG



SHOW  
Soundscape 2.0

VENUE  
UNCSA Library

DESIGNER  
NORA CUTHBERTSON

DRAFTER  
MATTHEW KUPFERER

NOTES

Saturday	2/5/22			0:00	0:00			0:00	0:00			0:00	0:00			0:00	0:00			0:00	0:00			0:00	0:00				
Sunday	2/6/22			0:00	0:00			0:00	0:00			0:00	0:00			0:00	0:00			0:00	0:00			0:00	0:00				
													Planned Weekly Total												5:00				
													Planned Weekly Average												8:15				
																								Actual Weekly Total			0:00		
																										Actual Weekly Average			5:00

Week 5	Date	Planned 1st Call Start	Planned 1st Call Stop	Hours	Break	Planned 2nd Call Start	Planned 2nd Call Stop	Hours	Break	Planned 3rd Call Start	Planned 3rd Call Stop	Hours	Planned Total	Actual 1st Call Start	Actual 1st Call Stop	Hours	Break	Actual 2nd Call Start	Actual 2nd Call Stop	Hours	Break	Actual 3rd Call Start	Actual 3rd Call Stop	Hours	Actual Total				
Monday	2/7/22			0:00	0:00			0:00	0:00			0:00	0:00			0:00	0:00			0:00	0:00			0:00	0:00				
Tuesday	2/8/22			0:00	0:00			0:00	0:00			0:00	0:00			0:00	0:00			0:00	0:00			0:00	0:00				
Wednesday	2/9/22			0:00	0:00			0:00	0:00			0:00	0:00			0:00	0:00			0:00	0:00			0:00	0:00				
Thursday	2/10/22	L-ISA Training		0:00	0:00			0:00	0:00			0:00	0:00	1:00 PM	5:30 PM	4:30	0:00			0:00	0:00			0:00	4:30				
Friday	2/11/22	L-ISA Training		0:00	0:00			0:00	0:00			0:00	0:00	9:00 AM	12:30 PM	3:30	1:00	1:30 PM	4:30 PM	3:00	0:00			0:00	6:30				
Saturday	2/12/22			0:00	0:00			0:00	0:00			0:00	0:00			0:00	0:00			0:00	0:00			0:00	0:00				
Sunday	2/13/22			0:00	0:00			0:00	0:00			0:00	0:00			0:00	0:00			0:00	0:00			0:00	0:00				
													Planned Weekly Total												0:00				
													Planned Weekly Average												6:36				
																								Actual Weekly Total			11:00		
																										Actual Weekly Average			6:12

Week 6	Date	Planned 1st Call Start	Planned 1st Call Stop	Hours	Break	Planned 2nd Call Start	Planned 2nd Call Stop	Hours	Break	Planned 3rd Call Start	Planned 3rd Call Stop	Hours	Planned Total	Actual 1st Call Start	Actual 1st Call Stop	Hours	Break	Actual 2nd Call Start	Actual 2nd Call Stop	Hours	Break	Actual 3rd Call Start	Actual 3rd Call Stop	Hours	Actual Total				
Monday	2/14/22			0:00	0:00			0:00	0:00			0:00	0:00			0:00	0:00			0:00	0:00			0:00	0:00				
Tuesday	2/15/22			0:00	0:00			0:00	0:00			0:00	0:00			0:00	0:00			0:00	0:00			0:00	0:00				
Wednesday	2/16/22			0:00	0:00			0:00	0:00			0:00	0:00			0:00	0:00			0:00	0:00			0:00	0:00				
Thursday	2/17/22			0:00	0:00			0:00	0:00			0:00	0:00			0:00	0:00			0:00	0:00			0:00	0:00				
Friday	2/18/22			0:00	0:00			0:00	0:00			0:00	0:00			0:00	0:00			0:00	0:00			0:00	0:00				
Saturday	2/19/22			0:00	0:00			0:00	0:00			0:00	0:00			0:00	0:00			0:00	0:00			0:00	0:00				
Sunday	2/20/22			0:00	0:00			0:00	0:00			0:00	0:00			0:00	0:00			0:00	0:00			0:00	0:00				
													Planned Weekly Total												0:00				
													Planned Weekly Average												5:30				
																								Actual Weekly Total			0:00		
																										Actual Weekly Average			5:10

Week 7	Date	Planned 1st Call Start	Planned 1st Call Stop	Hours	Break	Planned 2nd Call Start	Planned 2nd Call Stop	Hours	Break	Planned 3rd Call Start	Planned 3rd Call Stop	Hours	Planned Total	Actual 1st Call Start	Actual 1st Call Stop	Hours	Break	Actual 2nd Call Start	Actual 2nd Call Stop	Hours	Break	Actual 3rd Call Start	Actual 3rd Call Stop	Hours	Actual Total				
Monday	2/21/22			0:00	0:00			0:00	0:00			0:00	0:00			0:00	0:00			0:00	0:00			0:00	0:00				
Tuesday	2/22/22			0:00	0:00			0:00	0:00			0:00	0:00			0:00	0:00			0:00	0:00			0:00	0:00				
Wednesday	2/23/22			0:00	0:00			0:00	0:00			0:00	0:00			0:00	0:00			0:00	0:00			0:00	0:00				
Thursday	2/24/22			0:00	0:00			0:00	0:00			0:00	0:00			0:00	0:00			0:00	0:00			0:00	0:00				
Friday	2/25/22	Prepping for longer pipes		2:00 PM	3:00 PM	1:00	0:00		0:00			0:00	1:00	2:00 PM	4:00 PM	2:00	0:00			0:00	0:00			0:00	2:00				
Saturday	2/26/22			0:00	0:00			0:00	0:00			0:00	0:00			0:00	0:00			0:00	0:00			0:00	0:00				
Sunday	2/27/22			0:00	0:00			0:00	0:00			0:00	0:00			0:00	0:00			0:00	0:00			0:00	0:00				
													Planned Weekly Total												1:00				
													Planned Weekly Average												4:51				
																								Actual Weekly Total			2:00		
																										Actual Weekly Average			4:42

Week 8	Date	Planned 1st Call Start	Planned 1st Call Stop	Hours	Break	Planned 2nd Call Start	Planned 2nd Call Stop	Hours	Break	Planned 3rd Call Start	Planned 3rd Call Stop	Hours	Planned Total	Actual 1st Call Start	Actual 1st Call Stop	Hours	Break	Actual 2nd Call Start	Actual 2nd Call Stop	Hours	Break	Actual 3rd Call Start	Actual 3rd Call Stop	Hours	Actual Total
Monday	2/28/22	Setting up longer pipes		2:00 PM	4:00 PM	2:00	0:00		0:00			0:00	2:00	2:00 PM	3:00 PM	1:00	0:00			0:00	0:00			0:00	1:00
Tuesday	3/1/22			0:00	0:00			0:00	0:00			0:00	0:00			0:00	0:00			0:00	0:00			0:00	0:00
Wednesday	3/2/22			0:00	0:00			0:00	0:00			0:00	0:00			0:00	0:00			0:00	0:00			0:00	0:00
Thursday	3/3/22			0:00	0:00			0:00	0:00			0:00	0:00			0:00	0:00			0:00	0:00			0:00	0:00

TITLE  
ABI  
TIMESHEET

PLATE  
21  
22

DATE  
4-Apr-22

SCALE  
NO SCALE

FILENAME  
SOUNDSCAPE 3-25-AS.DWG

SHOW  
Soundscape 2.0

VENUE  
UNCSA Library

DESIGNER  
NORA CUTHBERTSON

DRAFTER  
MATTHEW KUPFERER

NOTES

Friday	3/4/22			0:00	0:00			0:00	0:00			0:00	0:00			0:00	0:00			0:00	0:00			0:00	0:00	
Saturday	3/5/22			0:00	0:00			0:00	0:00			0:00	0:00			0:00	0:00			0:00	0:00			0:00	0:00	
Sunday	3/6/22			0:00	0:00			0:00	0:00			0:00	0:00			0:00	0:00			0:00	0:00			0:00	0:00	
													Planned Weekly Total												Actual Weekly Total	1:00
													Planned Weekly Average												Actual Weekly Average	4:15

Week 9	Date	Planned 1st Call Start	Planned 1st Call Stop	Hours	Break	Planned 2nd Call Start	Planned 2nd Call Stop	Hours	Break	Planned 3rd Call Start	Planned 3rd Call Stop	Hours	Planned Total	Actual 1st Call Start	Actual 1st Call Stop	Hours	Break	Actual 2nd Call Start	Actual 2nd Call Stop	Hours	Break	Actual 3rd Call Start	Actual 3rd Call Stop	Hours	Actual Total	
Monday	3/7/22			0:00	0:00			0:00	0:00			0:00	0:00			0:00	0:00			0:00	0:00			0:00	0:00	
Tuesday	3/8/22			0:00	0:00			0:00	0:00			0:00	0:00			0:00	0:00			0:00	0:00			0:00	0:00	
Wednesday	3/9/22			0:00	0:00			0:00	0:00			0:00	0:00			0:00	0:00			0:00	0:00			0:00	0:00	
Thursday	3/10/22			0:00	0:00			0:00	0:00			0:00	0:00			0:00	0:00			0:00	0:00			0:00	0:00	
Friday	3/11/22			0:00	0:00			0:00	0:00			0:00	0:00			0:00	0:00			0:00	0:00			0:00	0:00	
Saturday	3/12/22			0:00	0:00			0:00	0:00			0:00	0:00			0:00	0:00			0:00	0:00			0:00	0:00	
Sunday	3/13/22			0:00	0:00			0:00	0:00			0:00	0:00			0:00	0:00			0:00	0:00			0:00	0:00	
													Planned Weekly Total												Actual Weekly Total	0:00
													Planned Weekly Average												Actual Weekly Average	3:46

Week 10	Date	Planned 1st Call Start	Planned 1st Call Stop	Hours	Break	Planned 2nd Call Start	Planned 2nd Call Stop	Hours	Break	Planned 3rd Call Start	Planned 3rd Call Stop	Hours	Planned Total	Actual 1st Call Start	Actual 1st Call Stop	Hours	Break	Actual 2nd Call Start	Actual 2nd Call Stop	Hours	Break	Actual 3rd Call Start	Actual 3rd Call Stop	Hours	Actual Total	
Monday	3/14/22			0:00	0:00			0:00	0:00			0:00	0:00			0:00	0:00			0:00	0:00			0:00	0:00	
Tuesday	3/15/22			0:00	0:00			0:00	0:00			0:00	0:00			0:00	0:00			0:00	0:00			0:00	0:00	
Wednesday	3/16/22			0:00	0:00			0:00	0:00			0:00	0:00			0:00	0:00			0:00	0:00			0:00	0:00	
Thursday	3/17/22			0:00	0:00			0:00	0:00			0:00	0:00			0:00	0:00			0:00	0:00			0:00	0:00	
Friday	3/18/22			0:00	0:00			0:00	0:00			0:00	0:00			0:00	0:00			0:00	0:00			0:00	0:00	
Saturday	3/19/22	Paperwork Corrections	10:00 AM	1:00 PM	3:00	0:00			0:00	0:00			0:00	3:00			0:00	0:00			0:00	0:00			0:00	0:00
Sunday	3/20/22			0:00	0:00			0:00	0:00			0:00	0:00			0:00	0:00			0:00	0:00			0:00	0:00	
													Planned Weekly Total												Actual Weekly Total	0:00
													Planned Weekly Average												Actual Weekly Average	3:24

Week 11	Date	Planned 1st Call Start	Planned 1st Call Stop	Hours	Break	Planned 2nd Call Start	Planned 2nd Call Stop	Hours	Break	Planned 3rd Call Start	Planned 3rd Call Stop	Hours	Planned Total	Actual 1st Call Start	Actual 1st Call Stop	Hours	Break	Actual 2nd Call Start	Actual 2nd Call Stop	Hours	Break	Actual 3rd Call Start	Actual 3rd Call Stop	Hours	Actual Total	
Monday	3/21/22	Paperwork Corrections	12:00 PM	1:00 PM	1:00	0:00			0:00	0:00			1:00			0:00	0:00			0:00	0:00			0:00	0:00	
Tuesday	3/22/22			0:00	0:00			0:00	0:00			0:00	0:00			0:00	0:00			0:00	0:00			0:00	0:00	
Wednesday	3/23/22			0:00	0:00			0:00	0:00			0:00	0:00			0:00	0:00			0:00	0:00			0:00	0:00	
Thursday	3/24/22			0:00	0:00			0:00	0:00			0:00	0:00			0:00	0:00			0:00	0:00			0:00	0:00	
Friday	3/25/22	Paperwork Corrections	10:00 AM	12:00 PM	2:00	0:00			0:00	0:00			2:00			0:00	0:00			0:00	0:00			0:00	0:00	
Saturday	3/26/22			0:00	0:00			0:00	0:00			0:00	0:00			0:00	0:00			0:00	0:00			0:00	0:00	
Sunday	3/27/22			0:00	0:00			0:00	0:00			0:00	0:00			0:00	0:00			0:00	0:00			0:00	0:00	
													Planned Weekly Total												Actual Weekly Total	0:00
													Planned Weekly Average												Actual Weekly Average	3:05

TITLE  
ABI  
TIMESHEET

PLATE  
22  
/22

DATE  
4-Apr-22

SCALE  
NO SCALE

FILENAME  
SOUNDSCAPE 3-25-AS.DWG